



DENTAL INSTRUMENTS CATALOGUE



W **TRUEWIN**
INDUSTRIES
Manufacturers & Exporters of Dental Instruments.



We, at **TRUEWIN** would like to
THANK YOU

for taking the time to browse through our catalog.

We realize we do not quite follow the norms.

We focus on expressing our total commitment to perfection when it comes to production-be it a catalog or an instruments. We have tried to convey to you our colleagues and friends that our instruments are designed to enhance your life so that you may continue with the beauty in life that it brings.

Precision - Perfection - Persistence

TRUEWIN
INDUSTRIES

Manufacturers & Exporters of Dental Instruments.

Roras Road New Miana Pura, Sialkot Pakistan

Ph: +92-52-3251044 Fax: +92-52-3251045

E-mail: info@truewin.com.pk truewin786@gmail.com

www.truewin.com.pk

Certificates





Truewin Dental Instruments

Truewin feels great honor to introduce itself as a renowned manufacturing company of dental & surgical instruments. Customers concerning to this field always prefer **Truewin instruments**, which makes us satisfied to our work.

Our all instruments are manufactured by the high quality stainless steel made on customers requirements, every instrument is hand crafted with the highest workmanship available in our industry. Through heat treatment, the instruments are hardened and tempered for proper functioning and attaining long life. All instruments are polished electrolytically and manually for maximum resistance to corrosion for a long working period.

Truewin pays special attention to the needs of doctors, with innovative designs to meet the needs of professionals. The wide assortment of standard patterns and exclusive designs gives you the most desirable range of surgical and dental instruments. Truewin will continue to produce and supply its quality products of surgical and dental instruments with best assurance.

QUALITY SERVICES & SATISFACTION

- * To provide 'Excellent services and reasonable prices' is the aim of our business.
 - * All instruments are made of international grades of stainless steels and worked under technical guidance of ASTM F899/11 standard.
 - * All instruments are stamped or laser marked the description that customer demands.
 - * Special items can also be supplied if sketch, drawing or samples are provided to us or referred as guidance.
- 1- 100% Inspection on machining and grinding stage.
 - 2- 100% Inspection after polishing
 - 3- 100% Inspection at final stage
 - 4- All above doing, 100% inspection are followed by 4% Inspection by Q.A. Manager
 - 5- Boil test of 10 pcs from each production lot.
 - 6- CopperSulphate test of 10 pcs from each produced lot.
 - 7- Material analysis test of 1 pcs from each produced lot.

All above stated inspections are performed to keep the certified criteria for each product to get assured quality instruments.

Quality Management System
Process Model

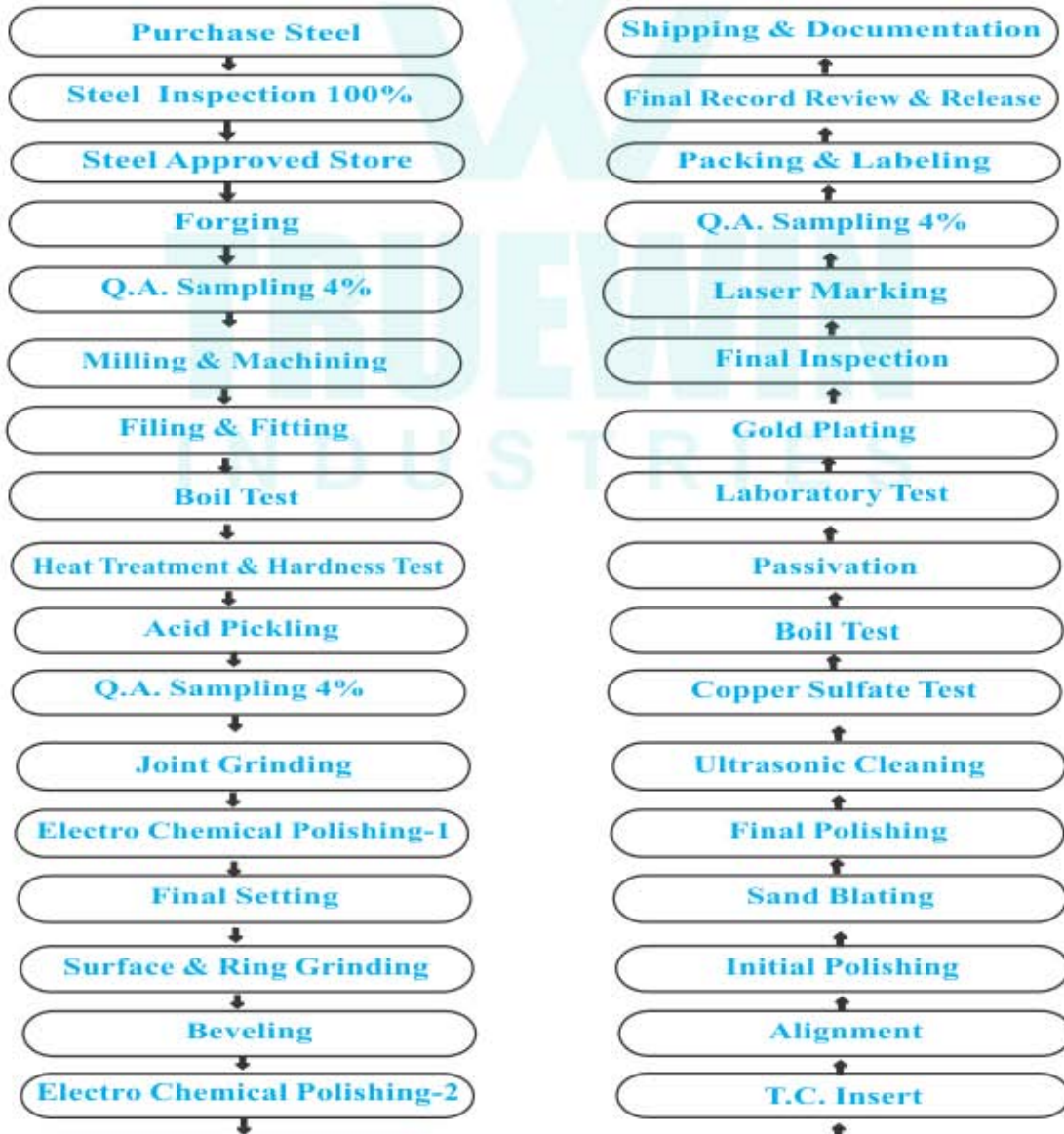
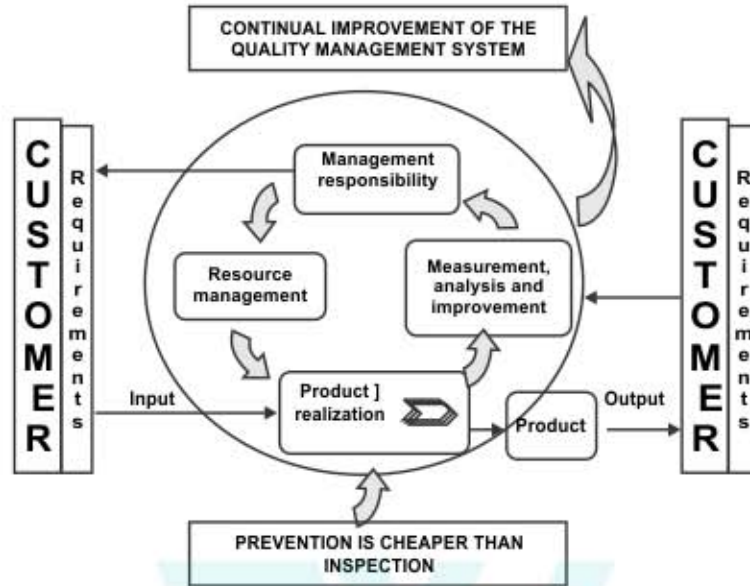

01 EXTRACTING FORCEPS 01 to 41

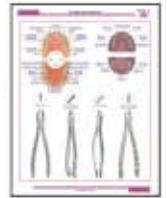

02 ROOT ELEVATORS 42 to 62



03 DIAGNOSTIC, PERIODONTAL & RESTORATIVE INSTRUMENTS 63 to 134



04 MAXILLOFACIAL SURGERY INSTRUMENTS 135 to 178



05 ORTHODONTIC PLIERS & INSTRUMENTS 179 to 201



06 DENTAL IMPLANT INSTRUMENTS 202 to 237



07 IMPRESSION TRAYS 238 to 255



08 HOLLOW WARE INSTRUMENTS 256 to 264



TRUEWIN
INDUSTRIES

The diagram illustrates the extraction points for various teeth in the upper and lower dental arches. The upper arch is labeled 'Up' and the lower arch 'Down', with 'Right' and 'Left' sides indicated. Extraction points are marked with colored dots and numbered boxes. The upper arch points include: 29,30,108,113; 1,29,30,113; 29,30,108,113; 1,107; 7,17,44N,51,52,53,65,89,92,94,95,96; 7,18,44N,51,52,53,65,90,93,94,95,97; 10,17,19,67,88,89,94; 10,18,19,67,88,90,95; 18; 28. The lower arch points include: 22,23,24,73,79; 22,23,24,73,79; 16,22,73,79,86,89; 13,75; 13,74,75A; 33,74,75A; 38; 37; 22,23,24,73,79; 16,22,73,79,86,89; 13,75; 13,74,75A; 43; 42; 41; 31; 32; 33. The lower arch also features two diagrams showing extraction points for specific teeth: 37,138; 39,157,128,159; 39,157,158; 160,161; 123,143; 123,162.

Four types of extraction forceps are shown below the diagrams:

- English Pattern:** A standard extraction forceps with a simple, curved beak and a textured handle.
- English Pattern, Anatomic Handle:** Similar to the English Pattern but with a more ergonomic, curved handle.
- American Pattern:** A forceps with a long, straight handle and a curved beak.
- Deep Grip Forceps With Hole Pattern:** A forceps with a long, straight handle featuring several circular holes for grip and a curved beak.

A) Extraction Forceps

Truewin Dental forceps are pliers-like instruments that are used to grasp teeth.

A dentist will usually have a number of different ones on hand, each having a design that's tailored to:

The specific shape of the tooth it's intended to remove (such as incisors vs. molars having two roots vs. molars having three roots).

The location of the tooth in the mouth (such as front vs. back, or left lower molar vs. right upper molar.)

How they're used.

A dentist will grasp a tooth with their forceps and then firmly and deliberately rock it back and forth as much as it will.

Because the bone that surrounds the tooth is compressible, the socket will gradually start to expand.

As it does, the range of the dentist's side-to-side motions will increase.

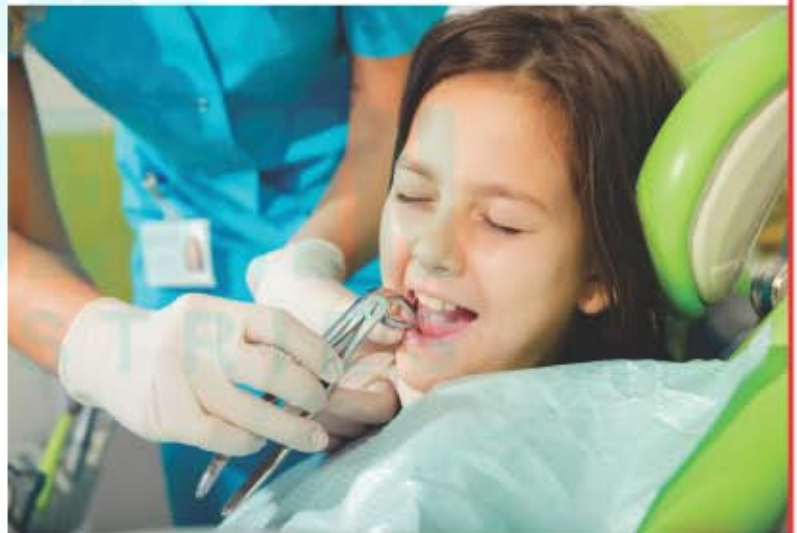

In addition to this rocking motion, the dentist will also rotate the tooth back and forth.

This twisting action helps to rip and tear the tooth away from the ligament that binds it in place.

At some point, the socket will be enlarged enough, and the ligament torn away enough, that the tooth can be easily removed.

EXTRACTING FORCEPS (English Pattern)



- Щипцы экстракционные (английская форма)
- Щипці екстракційні (англійська форма)
- Daviers (Forme Anglaise)
- Forceps de Extracción (Forme Inglesa)
- Zahnzangen (Englische Form)
- استخراج الملقط (نمط اللغة الإنجليزية)

FUNCTION: To remove teeth from bony socket



- Щипцы экстракционные (английская форма)
- Щипці екстракційні (англійська форма)
- Forceps de Extracció (Forme Inglesa)
- استخراج الملقط (نمط اللغة الإنجليزية)
- Daviers (Forme Anglaise)
- Forceps de Extracció (Forme Inglesa)
- Zahnzangen (Englische Form)

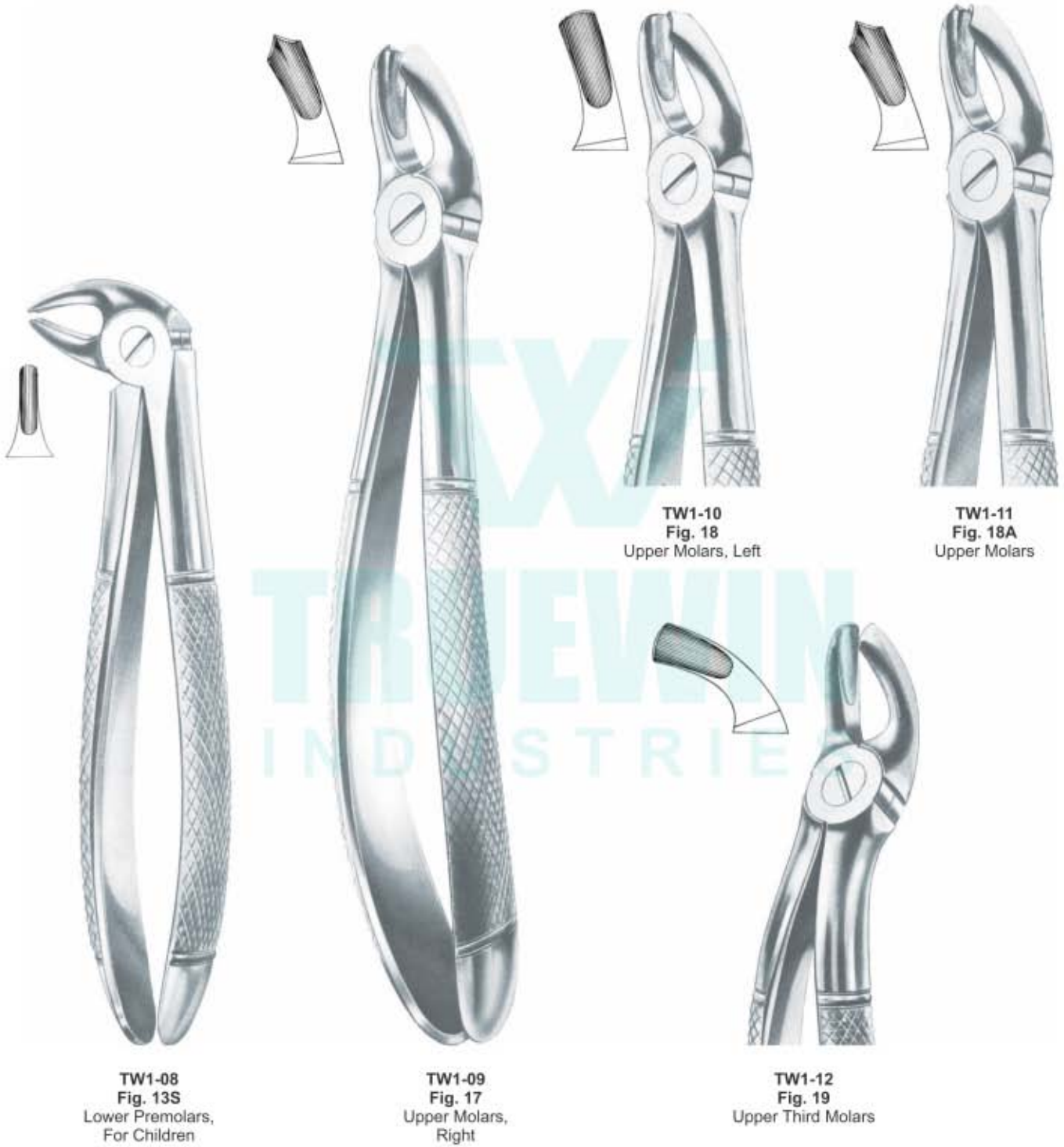

TW1-08
Fig. 13S
Lower Premolars,
For Children

TW1-09
Fig. 17
Upper Molars,
Right

TW1-10
Fig. 18
Upper Molars, Left

TW1-11
Fig. 18A
Upper Molars

TW1-12
Fig. 19
Upper Third Molars

EXTRACTING FORCEPS (English Pattern)



- Щипцы экстракционные (английская форма)
- Щипці екстракційні (англійська форма)
- Daviers (Forme Anglaise)
- Forceps de Extracción (Forme Inglesa)
- Zahnzangen (Englische Form)
- استخراج الملقط (نمط اللغة الإنجليزية)



TW1-13
Fig. 20
Lower Third Molar



TW1-14
Fig. 21
Lower Molar



TW1-15
Fig. 22
Lower Molar



TW1-16
Fig. 22S
Lower Molar,
For Children



TW1-17
Fig. 22G
Lower Molar



TW1-18
Fig. 23
Lower Molar, Right



TW1-19
Fig. 24
Lower Molar, Left

- Щипцы экстракционные (английская форма)
- Daviers (Forme Anglaise)
- Zahnzangen (Englische Form)
- Щипці екстракційні (англійська форма)
- Forceps de Extracción (Forme Inglesa)
- استخراج الملقط (نمط اللغة الإنجليزية)



TW1-20
Fig. 29
Upper Roots



TW1-21
Fig. 29N
Roots of Upper Incisors



TW1-22
Fig. 29S
Upper Roots, For Children



TW1-23
Fig. 30
Upper Roots



TW1-25
Fig. 31
Lower Roots



TW1-26
Fig. 32
Lower Molars



TW1-24
Fig. 30S
Upper Roots, For Children

EXTRACTING FORCEPS (English Pattern)



- Щипцы экстракционные (английская форма)
- Daviers (Forme Anglaise)
- Zahnzangen (Englische Form)
- Щипці екстракційні (англійська форма)
- Forceps de Extracción (Forme Inglesa)
- استخراج الملقط (نمط اللغة الإنجليزية)



TW1-27
Fig. 33
Lower Roots



TW1-28
Fig. 33A
Lower Roots



TW1-29
Fig. 33C
Lower Roots



TW1-30
Fig. 33M
Lower Roots
With Long Beak



TW1-31
Fig. 33S
Lower Roots,
For Children



TW1-32
Fig. 38
Lower Incisors and Canines,
For Children



TW1-33
Fig. 41
Upper Roots



TW1-34
Fig. 44
Upper Roots



TW1-35
Fig. 45
Lower Roots



TW1-36
Fig. 49
Upper Roots

- Щипцы экстракционные (английская форма)
- Daviers (Forme Anglaise)
- Zahnzangen (Englische Form)
- Щипці екстракційні (англійська форма)
- Forceps de Extracción (Forme Inglesa)
- استخراج الملقط (نمط اللغة الإنجليزية)



TW1-37
Fig. 51
Upper Roots



TW1-38
Fig. 51 S
Upper Roots,
For Children



TW1-39
Fig. 51 A
Upper Roots

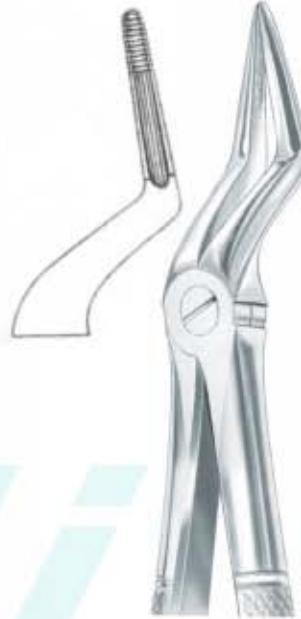

TW1-40
Fig. 51 C
Upper Roots



TW1-41
Fig. 51 L
Upper Roots



TW1-42
Fig. 52
Upper Roots & Canines
With Wider Beak



TW1-43
Fig. 52 A
Upper Teeth
and Resection

EXTRACTING FORCEPS (English Pattern)



- Щипцы экстракционные (английская форма)
- Daviers (Forme Anglaise)
- Zahnzangen (Englische Form)
- Щипці екстракційні (англійська форма)
- Forceps de Extracció (Forme Inglesa)
- استخراج الملقط (نمط اللغة الإنجليزية)



TW1-44
Fig. 54
For Separating
Upper Molars



TW1-45
Fig. 55
For Separating
Upper Molars



TW1-46
Fig. 56
For Separating
Lower Molars



TW1-47
Fig. 67
Upper Third
Molars



TW1-48
Fig. 67A
Upper Third
Molars

- Щипцы экстракционные (английская форма)
- Щипці екстракційні (англійська форма)
- Daviers (Forme Anglaise)
- Forceps de Extracción (Forme Inglesa)
- Zahnzangen (Englische Form)
- استخراج الملقط (نمط اللغة الإنجليزية)



TW1-49
Fig. 67 1/2 R
Upper Third
Molars, Right

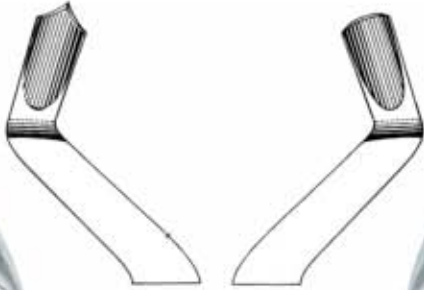

TW1-50
Fig. 67 1/2 L
Upper Third
Molars, Left



TW1-51
Fig. 68
Lower Roots



TW1-52
Fig. 73
Lower Molars



TW1-53
Fig. 74
Lower Roots



TW1-54
Fig. 74 D
Lower Roots



TW1-55
Fig. 74M
Lower Roots

EXTRACTING FORCEPS (English Pattern)



- Щипцы экстракционные (английская форма)
- Daviers (Forme Anglaise)
- Zahnzangen (Englische Form)
- Щипці екстракційні (англійська форма)
- Forceps de Extracción (Forme Inglesa)
- استخراج الملقط (نمط اللغة الإنجليزية)



TW1-56
Fig. 74N
Lower Roots



TW1-57
Fig. 74XN
Lower Roots and
Crowded Incisors



TW1-58
Fig. 75
Lower Premolars



TW1-63
Fig. 79A
Lower Third Molars



TW1-59
Fig. 76
Upper Roots



TW1-60
Fig. 76N
Upper Roots



TW1-61
Fig. 76S
Upper Roots
for children



TW1-62
Fig. 79
Lower Third Molars

- Щипцы экстракционные (английская форма)
- Daviers (Forme Anglaise)
- Zahnzangen (Englische Form)
- Щипці екстракційні (англійська форма)
- Forceps de Extracción (Forme Inglesa)
- استخراج الملقط (نمط اللغة الإنجليزية)



TW1-64
Fig. 86A
Lower Molars



TW1-65
Fig. 86B
Lower Molars



TW1-66
Fig. 86C
Lower Molars



TW1-67
Fig. 87
Lower Molars

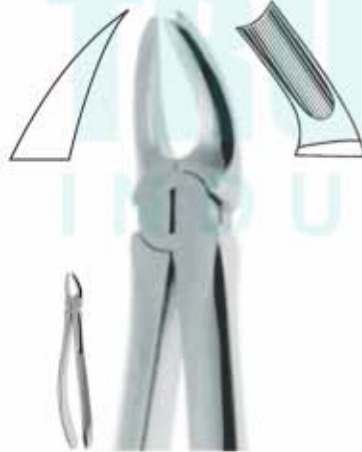

TW1-68
Fig. 89
Upper Molars,
Right

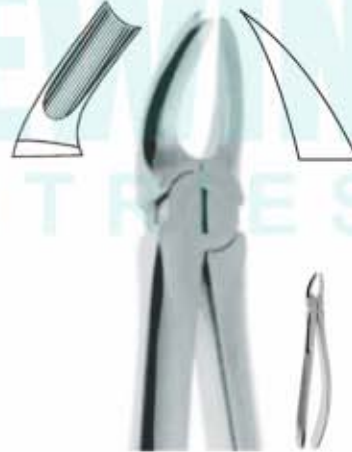

TW1-69
Fig. 90
Upper Molars,
Left

EXTRACTING FORCEPS (English Pattern)



- Щипцы экстракционные (английская форма)
- Daviers (Forme Anglaise)
- Zahnzangen (Englische Form)
- Щипці екстракційні (англійська форма)
- Forceps de Extracción (Forme Inglesa)
- استخراج الملقط (نمط اللغة الإنجليزية)



TW1-70
Fig. 94
Upper Molars,
Right



TW1-71
Fig. 95
Upper Molars,
Left



TW1-72
Fig. 99
Lower Molars



TW1-73
Fig. 99 1/4
Lower Molars



TW1-74
Fig. MD1
Mead
Upper Anteriors,
Roots

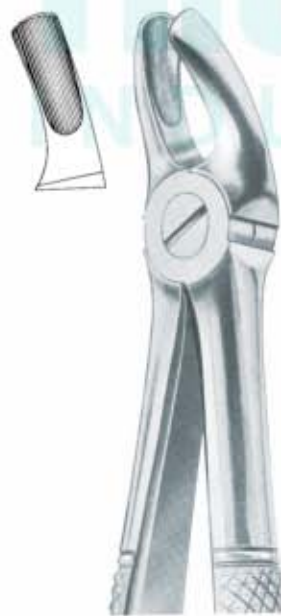

TW1-75
Fig. MD2
Mead
Upper Molars



TW1-76
Fig. MD3
Mead
Lower Roots



TW1-77
Fig. MD4
Mead
Lower Molars

- Щипцы экстракционные (английская форма)
- Daviers (Forme Anglaise)
- Zahnzangen (Englische Form)
- Щипці екстракційні (англійська форма)
- Forceps de Extracción (Forme Inglesa)
- استخراج الملقط (نمط اللغة الإنجليزية)



TW1-78
Fig. 121
Upper Third
Molars



TW1-79
Fig. 136
Upper Premolars
and Roots

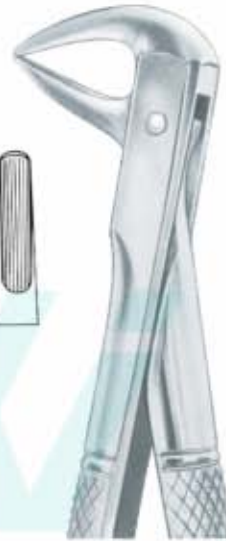

TW1-80
Fig. 137
Lower Incisors
and Roots



TW1-81
Fig. 167
Universal Patter
For Lower Teeth
Molars & Premolars



TW1-82
Fig. 168
Upper Canines



TW1-83
Fig. 169
Lower Canines &
Premolars



TW1-84
Fig. 233
Lower Root
(Parallel Beaks)

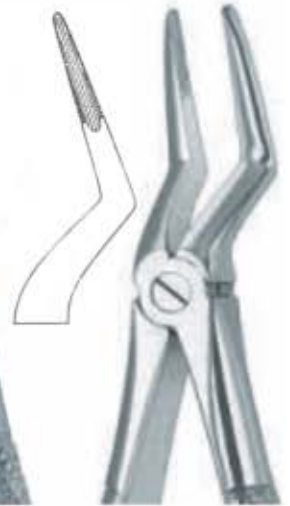

TW1-85
Fig. 235
Upper Root
(Parallel Beaks)

EXTRACTING FORCEPS (English Pattern)



- Щипцы экстракционные (английская форма)
- Daviers (Forme Anglaise)
- Zahnzangen (Englische Form)
- Щипці екстракційні (англійська форма)
- Forceps de Extracció (Forme Inglesa)
- استخراج الملقط (نمط اللغة الإنجليزية)



TW1-86
Fig. 158
Children's Upper Teeth Molars Universal



TW1-87
Fig. 159
Children's upper Molars Universal

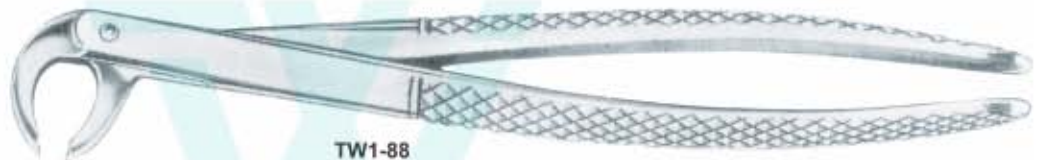

TW1-88
Fig. 160
Children's Upper Lower Universal (Hawk's Bill)

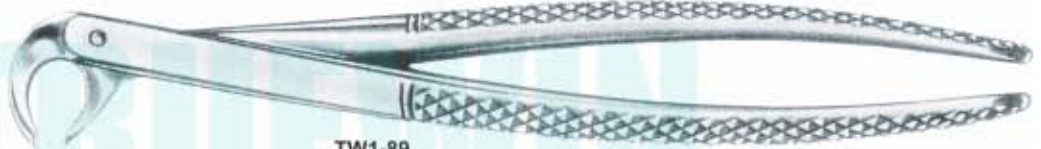

TW1-89
Fig. 161
Children's Lower Centrals & Roots

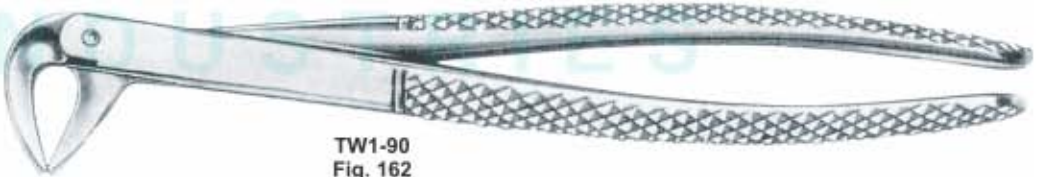

TW1-90
Fig. 162
Children's Upper Centrals



TW1-91
Fig. 163
Children's Upper Centrals

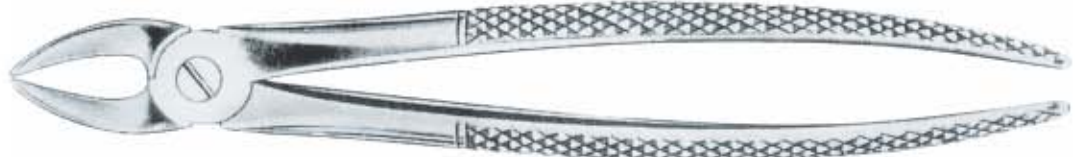

TW1-92
Fig. 37
Children's Upper Incisors & Canines

- Щипцы экстракционные (английская форма)
- Daviers (Forme Anglaise)
- Zahnzangen (Englische Form)
- Щипці екстракційні (англійська форма)
- Forceps de Extracción (Forme Inglesa)
- استخراج الملقط (نمط اللغة الإنجليزية)

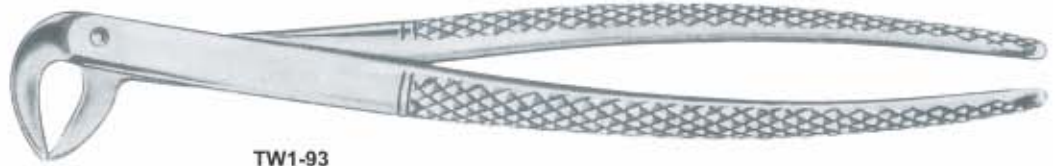

TW1-93
Fig. 123
Children's Lower Teeth Universal

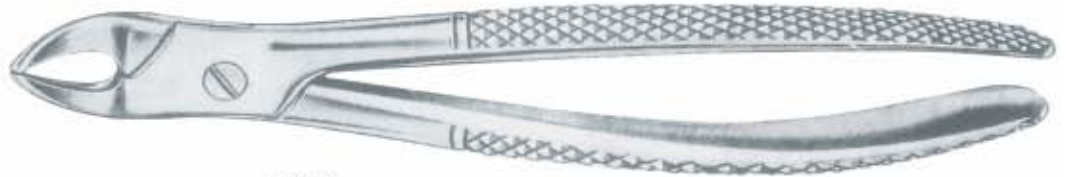

TW1-94
Fig. 138
Children's Upper Universal & Roots

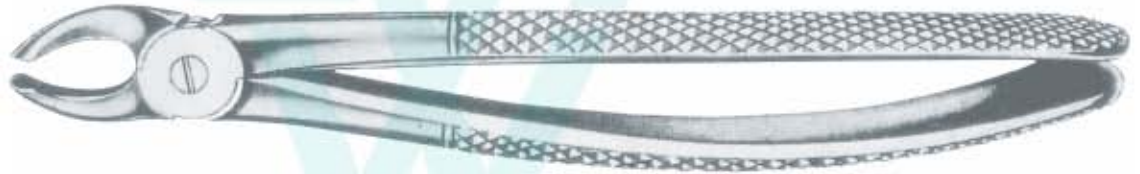

TW1-95
Fig. 157
Children's Upper Morals Universal

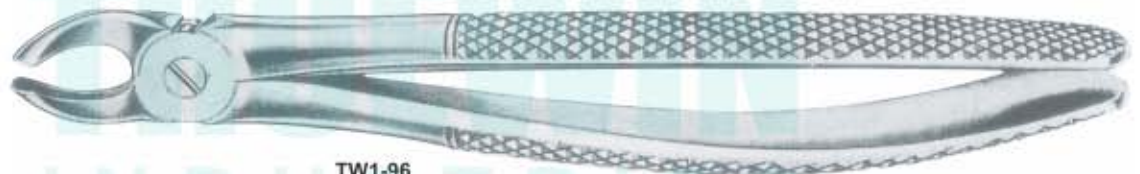

TW1-96
Fig. 39
Children's Upper Morals Universal

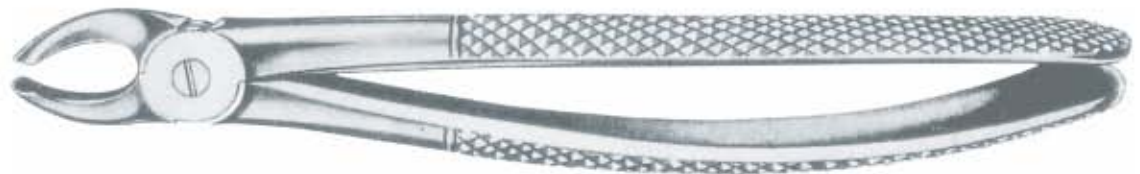

TW1-97
Fig. 39R
Children's Upper Morals Right

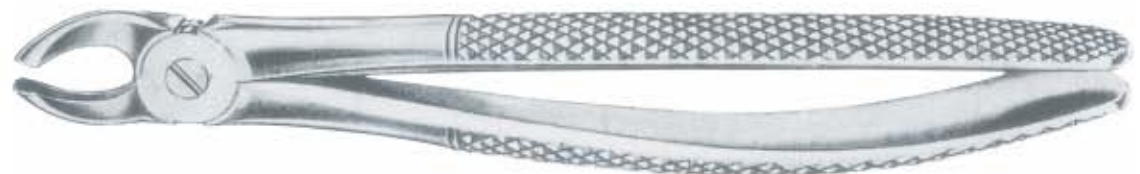

TW1-98
Fig. 39L
Children's Upper Morals Left

EXTRACTING FORCEPS (For Children)



- Щипцы экстракционные детские
- Щипці екстракційні дитячі
- Daviers - forme anglaise
- Fórceps de extracció n - forma inglesa
- Pinzoper per estrazione per bambini
- استخراج المثلث (للأطفال)

Pediatric Tooth Extracting Forceps



TW1-99
English Pattern
Klein #51S
Pedodontic Upper root



TW1-100
English Pattern
Klein #139
Pedodontic Upper Premolars



TW1-101
English Pattern
Klein #3
Pedodontic Upper Molars Universal



TW1-102
English Pattern
Klein #137
Pedodontic, Upper Incisors



TW1-103
English Pattern Klein #5
Pedodontic Lower Incisors.



TW1-104
English Pattern
Klein #6
Pedodontic Lower Molars



TW1-106
Set of 7 Pieces



TW1-105
English Pattern
Klein #7
Pedodontic Lower Molars,



Baby Tooth Extraction Forceps

- Щипцы экстракционные для зубов мудрости (английская форма)
- Dавiers (Forme Anglaise)
- Zahnzangen (Englische Form)
- Щипці екстракційні для зубів мудрості (англійська форма)
- Forceps de Extracción (Forme Inglesa)
- الحفظة استخراج المثلث



TW1-107
Routerier
Fig. 22 ½ L
Lower Molars and
Wisdoms, Left



TW1-108
Routerier
Fig. 22 ½ R
Lower Molars and
Wisdoms, Right



TW1-109
Routerier
Fig. 33 ½ L
Lower Molar and
Wisdom Roots, Left



TW1-110
Routerier
Fig. 33 ½ R
Lower Molar and
Wisdom Roots, Right



TW1-111
Fig. 186L
Lower Molars



TW1-112
Fig. 186R
Lower Molars

TRUEWIN
INDUSTRIES

EXTRACTING FORCEPS (English Pattern)



- Щипцы экстракционные (английская форма)
- Щипці екстракційні (англійська форма)
- Daviers (Forme Anglaise)
- Forceps de Extracción (Forme Inglesa)
- Zahnzangen (Englische Form)
- استخراج الملقط (نمط اللغة الإنجليزية)

Deep Gripping Root Forceps



TW1-113
Fig. 146
Upper Roots



TW1-114
Fig. 149
Lower Roots



TW1-115
Fig. 153
Upper Roots

- Щипцы для удаления корневых осколков
- Pincers Fragments
- Wurzelsplitterzangen

- Щипці для видалення корневих осколків
- Pinzas Para Fragmentos
- جنور منشقة الملقط



TW1-116
Universal Pattern For
Upper Teeth



TW1-117
Universal Pattern For
Lower Teeth



TW1-118
Ralk
Root Fragments



TW1-119
Stieglitz
Root Fragments



TW1-120
Stieglitz
Root Fragments



TW1-121
Arthur
Root Fragments

EXTRACTING FORCEPS (For Children)



- Щипцы экстракционные детские
- Daviers - forme anglaise
- Pinzeper per estrazione per bambini
- Щипці екстракційні дитячі
- Fórceps de extracci6n - forma inglesa
- استخراج المنقط (للأطفال)



TW1-122
Koehler
Luxation Forceps
Right & Left Molars

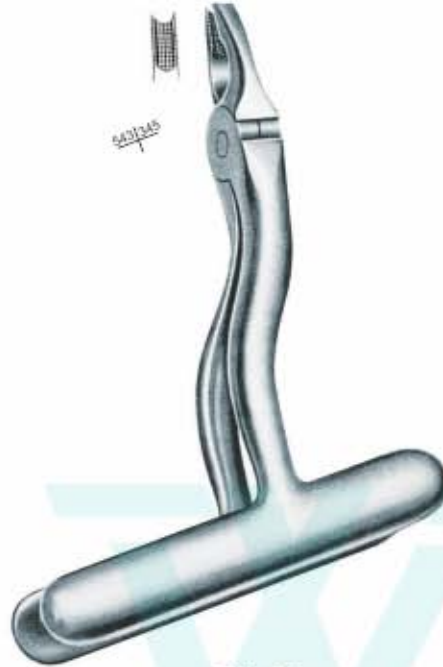

TW1-123
Upper Canines
& Premolars

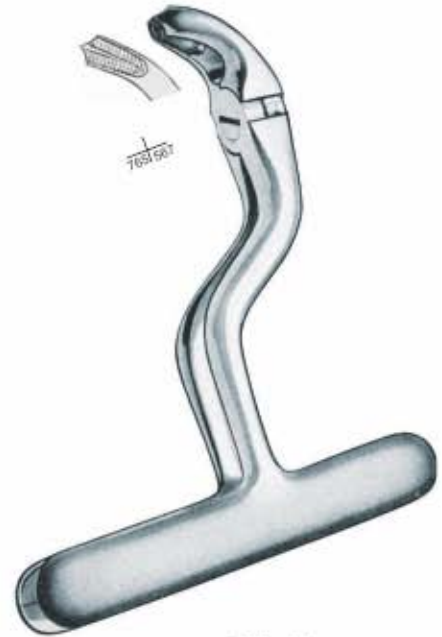

TW1-124
Lower Molars
Either Side



TW1-125
Lower Third Molars



TW1-126
Albrecht
160mm



TW1-127
Albrecht
160mm

deciduous teeth

- Щипцы экстракционные детские
- Daviers - forme anglaise
- Pinzeper per estrazione per bambini
- Щипці екстракційні дитячі
- Fórceps de extracció - forma inglesa
- استخراج المثلث (للأطفال)



TW1-128
Fig.10 SK
Upper Molars Sup, 10SK



TW1-129
Fig.17 SK
Universal
Lower Molars



TW1-130
Fig.23 SK
Universal
Upper Molars



TW1-131
Fig. 69 SK
Tomas
Upper and Lower Roots

TRUEWIN
INDUSTRIES



TW1-132
Fig. 99 SK
Upper Incisors,
Canines, Premolars



TW1-133
Fig. 150 SK
Upper Incisors,
Premolars, Roots



TW1-134
Fig. 151 SK
Lower Incisors,
Premolars, Roots



TW1-135
Fig. 222 SK
Lower Third Molars

EXTRACTING FORCEPS (For Children)



- Щипцы экстракционные детские
- Daviers - forme anglaise
- Pinzeper per estrazione per bambini
- Щипці екстракційні дитячі
- Fórceps de extracció n - forma inglesa
- استخراج المنقط (للأطفال)



TW1-136
Fig. 151 SK
Lower Incisors,
Premolars, Roots

TW1-137
Fig. 222 SK
Lower Third Molars

TW1-138
Fig. 560
Upper Incisors

- Щипцы экстракционные (английская форма)
- Щипці екстракційні (англійська форма)
- Daviers (Forme Anglaise)
- Forceps de Extracció (Forme Inglesa)
- Zahnzangen (Englische Form)
- استخراج الملقط (نمط اللغة الإنجليزية)

Deep Gripping Root Forceps

TW1-139
Upper Centrals
Fig. 34A



TW1-140
Upper Premolar
Fig. 35A



TW1-141
Upper Roots
Fig. 331



TW1-142
Lower Premolar
Fig. 336



TW1-143
Lower Premolar
Fig. 36A



EXTRACTING FORCEPS (English Pattern)



- Щипцы экстракционные (английская форма)
- Щипці екстракційні (англійська форма)
- Daviers (Forme Anglaise)
- Forceps de Extracción (Forme Inglesa)
- Zahnzangen (Englische Form)
- استخراج الملقط (نمط اللغة الإنجليزية)

Deep Gripping Root Forceps

TW1-144
Upper Third Molars
Fig. 67N



TW1-145
Lower Third Molars
Fig. 79N



TW1-146
Upper Premolars
Fig. 7N



TW1-147
Lower Premolars
Fig. 36N

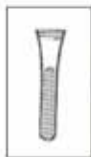

- Щипцы экстракционные (английская форма)
- Daviers (Forme Anglaise)
- Zahnzangen (Englische Form)
- Щипці екстракційні (англійська форма)
- Forceps de Extracción (Forme Inglesa)
- استخراج الملقط (نمط اللغة الإنجليزية)

(Deep Gripe Extracting Forceps)



- No Fracture
- No Tissue Damage
- Extraction With Easy

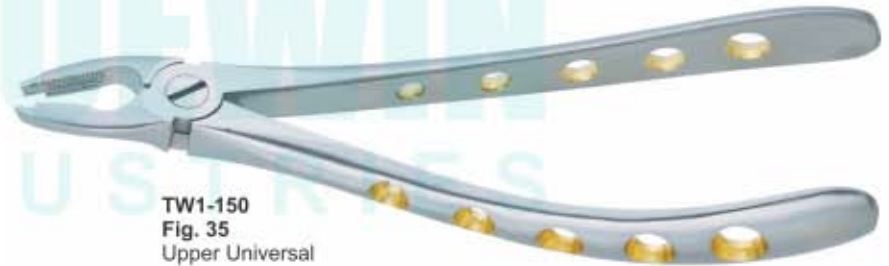
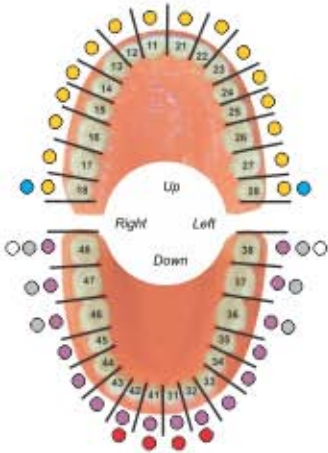

A-TRAUMATIC EXTRACTION FORCEPS
Improved tapered beaks for complete root contact.
.Cross serrations for a never slip grasp.
Easily enter the sub gingival.

- Щипцы экстракционные (английская форма)
- Daviers (Forme Anglaise)
- Zahnzangen (Englische Form)
- Щипці екстракційні (англійська форма)
- Forceps de Extracción (Forme Inglesa)
- استخراج الملقط (نمط اللغة الإنجليزية)

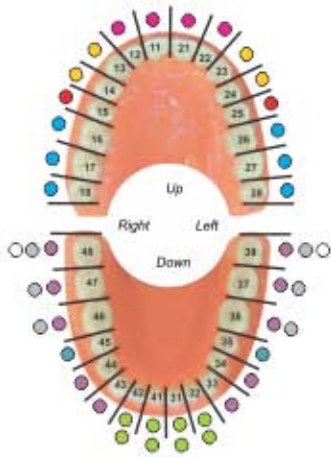

Deep Root Pick Forceps

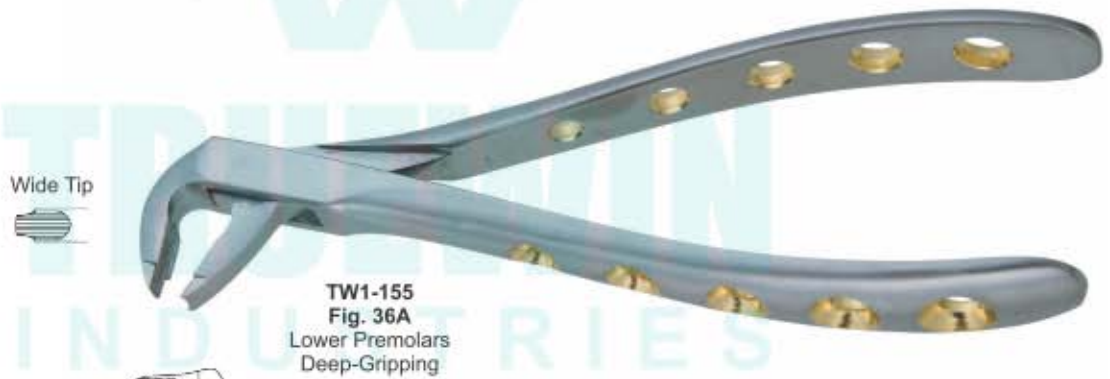
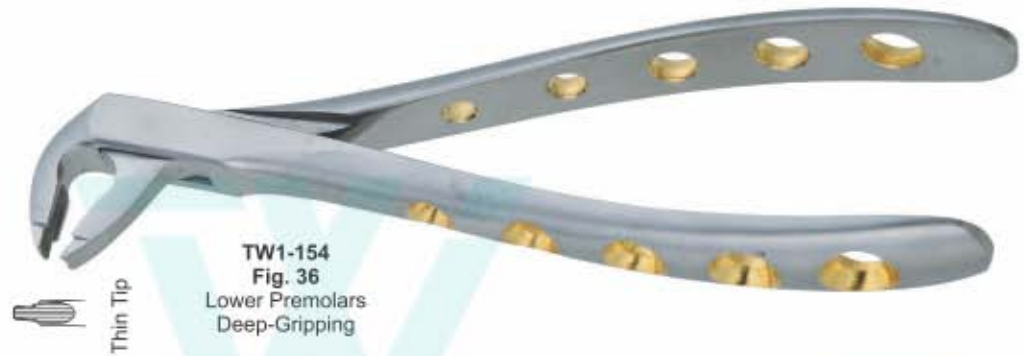

- Щипцы экстракционные (английская форма)
- Daviers (Forme Anglaise)
- Zahnzangen (Englische Form)
- Щипці екстракційні (англійська форма)
- Forceps de Extracción (Forme Inglesa)
- استخراج الملقط (نمط اللغة الإنجليزية)

DEEP ROOT PICK FORCEPS

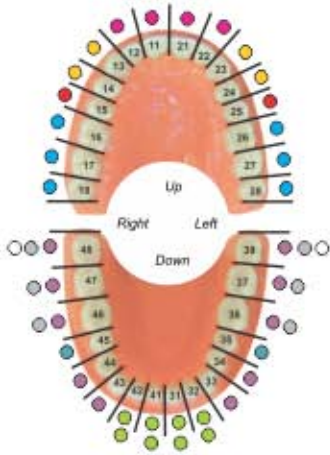

- Щипцы экстракционные (английская форма)
- Daviers (Forme Anglaise)
- Zahnzangen (Englische Form)
- Щипці екстракційні (англійська форма)
- Forceps de Extracción (Forme Inglesa)
- استخراج الملقط (نمط اللغة الإنجليزية)

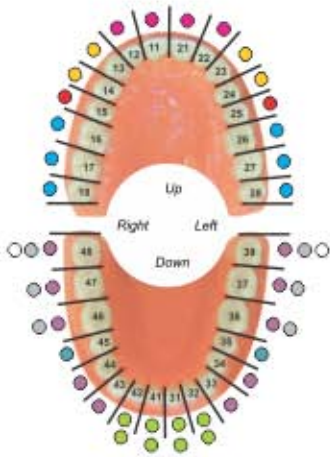

DEEP ROOT PICK FORCEPS



TW1-163
Fig. 51
Apex Forceps
Upper Root
Deep Root Pick



TW1-164
Fig. 46XL
Apex Forceps Lower Root
Deep Root Pick



TW1-165
Upper Root
Fig. 44



TW1-166
Lower Root
Fig. 45



TW1-167
Upper Root
Fig. 51

- Щипцы экстракционные (американская форма)
- Daviers - forme américaine
- Fórceps de extracción - forma americana
- Щипці екстракційні (американська форма)
- Pinzeta per estrazione - forma americana
- استخراج المفلط (النمط الأمريكي)



TW1-168
Fig. W1
 Winter
 upper centrals
 and canines

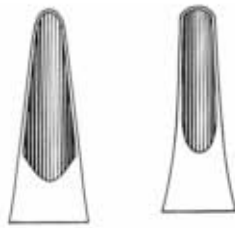

TW1-169
Fig. 1
 upper incisors
 and roots



TW1-170
Fig. 2
 upper and
 lower roots



TW1-171
Fig. 10S
 upper molars



TW1-172
Fig. 5
 Physick
 lower third molars

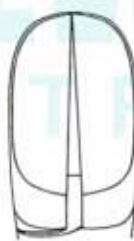

TW1-173
Fig. 6
 separating forceps



TW1-174
Fig. 10 H
 upper molars

EXTRACTING FORCEPS (American Pattern)



- Щипцы экстракционные (американская форма)
- Daviers - forme américaine
- Fórceps de extracción - forma americana
- Щипці екстракційні (американська форма)
- Pinzere per estrazione - forma americana
- استخراج المفلط (النمط الأمريكي)

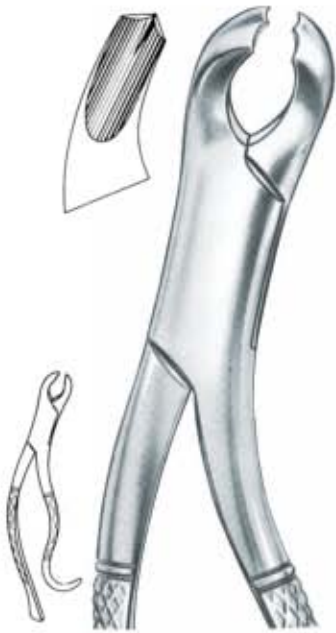

TW1-175
Fig. 15
Harris
lower molars



TW1-177
Fig. 16
lower molars

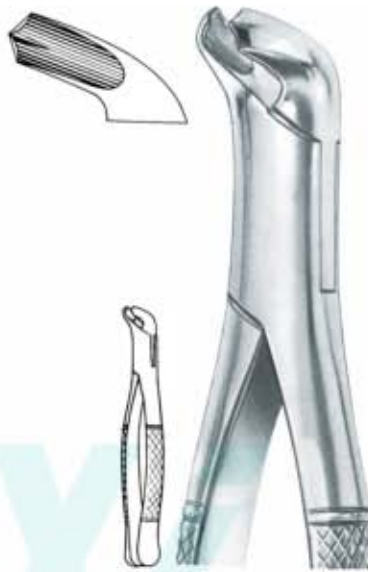

TW1-178
Fig. 17
lower molars

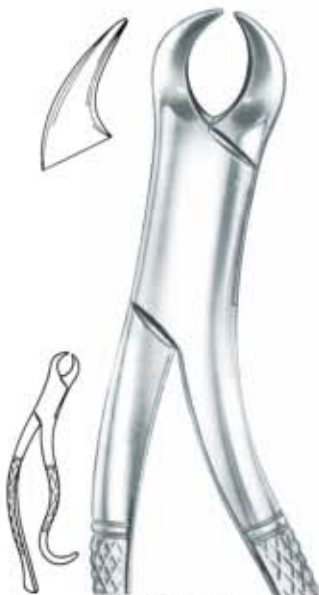

TW1-176
Fig. 16S
lower molars
for children



TW1-179
Fig. 18 L
Harris
upper molars, left



TW1-180
Fig. 18R
Harris
upper molars, right

- Щипцы экстракционные (американская форма)
- Daviers - forme américaine
- Fórceps de extracción - forma americana
- Щипці екстракційні (американська форма)
- Pinzere per estrazione - forma americana
- استخراج الملقط (النمط الأمريكي)

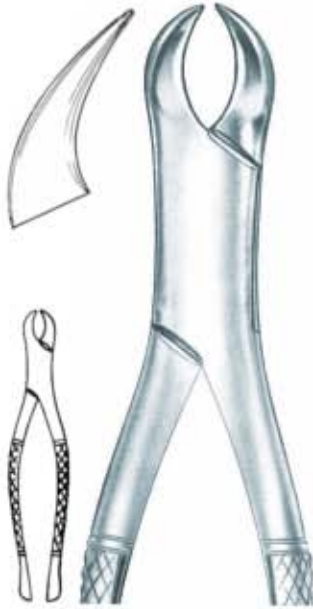

TW1-181
Fig. 23
lower molars



TW1-183
Fig. 32 Parmly
upper premolars
and molars



TW1-186
Fig. 53 L
upper molars, left



TW1-182
Fig. 24
upper molars

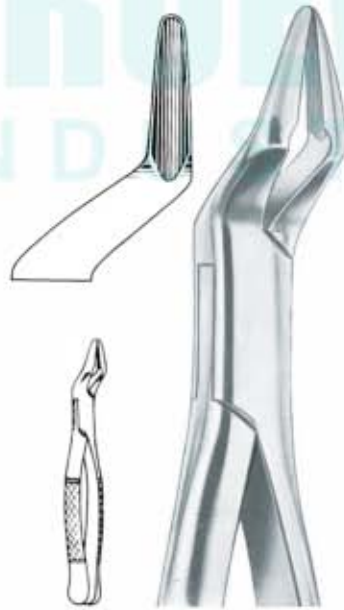

TW1-184
Fig. 32A Parmly
upper premolars
and roots



TW1-185
Fig. 53 R
upper molars, right

EXTRACTING FORCEPS (American Pattern)



- Щипцы экстракционные (американская форма)
- Щипці екстракційні (американська форма)
- Daviers - forme américaine
- Pinzere per estrazione - forma americana
- Fórceps de extracción - forma americana
- استخراج الملقط (النمط الأمريكي)



TW1-187
Fig. 62
incisors, premolars,
deciduous teeth



TW1-188
Fig. 65
upper incisors
and roots



TW1-189
Fig. 69 Tomas
upper and lower
roots



TW1-190
Fig. 88R Nevius
upper molars, right



TW1-191
Fig. 88L Nevius
upper molars, left

- Щипцы экстракционные (американская форма)
- Daviers - forme américaine
- Fórceps de extracción - forma americana
- Щипці екстракційні (американська форма)
- Pinzere per estrazione - forma americana
- استخراج المفلط (النمط الأمريكي)



TW1-192
Fig. 150
Cryer
upper incisors,
premolars, roots



TW1-193
Fig. 150A
Cryer
upper incisors,
premolars, roots



TW1-194
Fig. 150S
Cryer
upper teeth, for children



TW1-195
Fig. 151A
Cryer
lower incisors,
premolars, roots



TW1-196
Fig. 151 S
Cryer
lower teeth,
for children



TW1-197
Fig. 151
Cryer
lower incisors,
premolars, roots

EXTRACTING FORCEPS (American Pattern)



- Щипцы экстракционные (американская форма)
- Daviers - forme américaine
- Fórceps de extracción - forma americana
- Щипці екстракційні (американська форма)
- Pinzeta per estrazione - forma americana
- استخراج المنطق (النمط الأمريكي)



TW1-198
Fig. 99C
Kells
upper incisors,
canines, premolars



TW1-199
Fig. 101
Hull
Deciduous teeth



TW1-200
Fig. 210S
upper third molars



TW1-201
Fig. 217
lower molars



TW1-202
Fig. 210H
upper third molars

- Щипцы экстракционные (американская форма)
- Daviers - forme américaine
- Fórceps de extracción - forma americana
- Щипці екстракційні (американська форма)
- Pinzeta per estrazione - forma americana
- استخراج المفلط (النمط الأمريكي)



TW1-203
Fig. 23 S
Lower molars



TW1-204
Fig. 222
lower third molars



TW1-205
Fig. 1 A Henahan
upper incisors



TW1-206
Fig. 286
upper incisors
and roots



TW1-207
Fig. 17 SK
Lower molars



TW1-208
Fig. 150 SK
Upper anteriors
and roots



TW1-209
Fig. 151 SK
lower anteriors
and roots

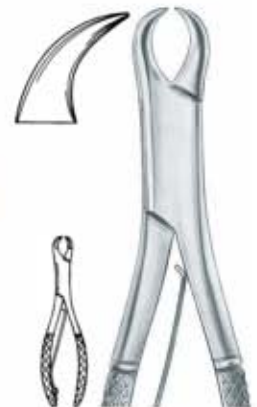

TW1-210
Fig. 23 SK
Lower molars

EXTRACTING FORCEPS (American Pattern)



- Щипцы экстракционные (американская форма)
- Щипці екстракційні (американська форма)
- Daviers - forme américaine
- Pinzere per estrazione - forma americana
- Fórceps de extracción - forma americana
- استخراج المنقط (النمط الأمريكي)



TW1-211
Fig. 1
Upper Anterior



TW1-212
Lower Molar
Fig. 23 Cow Horn



TW1-213
Fig. 88L
Upper Molar Left



TW1-214
Fig. 88R
Upper Molar Right



TW1-215
Fig. 150
Upper Universal

EXTRACTING FORCEPS (American Pattern)

- Щипцы экстракционные (американская форма)
- Щипці екстракційні (американська форма)
- Daviers - forme américaine
- Pinzere per estrazione - forma americana
- Fórceps de extracción - forma americana
- استخراج المنقط (النمط الأمريكي)



TW1-216
Fig. 150S
Upper Universal



TW1-217
Fig. 151
Lower Universal



TW1-218
Fig. 151S
Lower Universal



TW1-219
Fig. 106
Lower Incisors



TW1-220
Fig. 174
Extra Narrow Lower Anterior
Apical Retention Forceps

EXTRACTING FORCEPS (American Pattern)



- Щипцы экстракционные (американская форма)
- Daviers - forme américaine
- Fórceps de extracción - forma americana
- Щипці екстракційні (американська форма)
- Pinzere per estrazione - forma americana
- استخراج المنقط (النمط الأمريكي)



TW1-221
Right



TW1-222
Left



TW1-223
Easy Access to molars Right



TW1-224
Easy Access to molars Left



TW1-225
Upper Right



TW1-226
Upper Anterior



TW1-227
Upper Left



TW1-228
Lower Universal



TW1-229
Standard Set of Forceps System Stand



EXTRACTING FORCEPS (American Pattern)

- Щипцы экстракционные (американская форма)
- Daviers - forme américaine
- Fórceps de extracción - forma americana
- Щипці екстракційні (американська форма)
- Pinzeta per estrazione - forma americana
- استخراج الملقط (النمط الأمريكي)

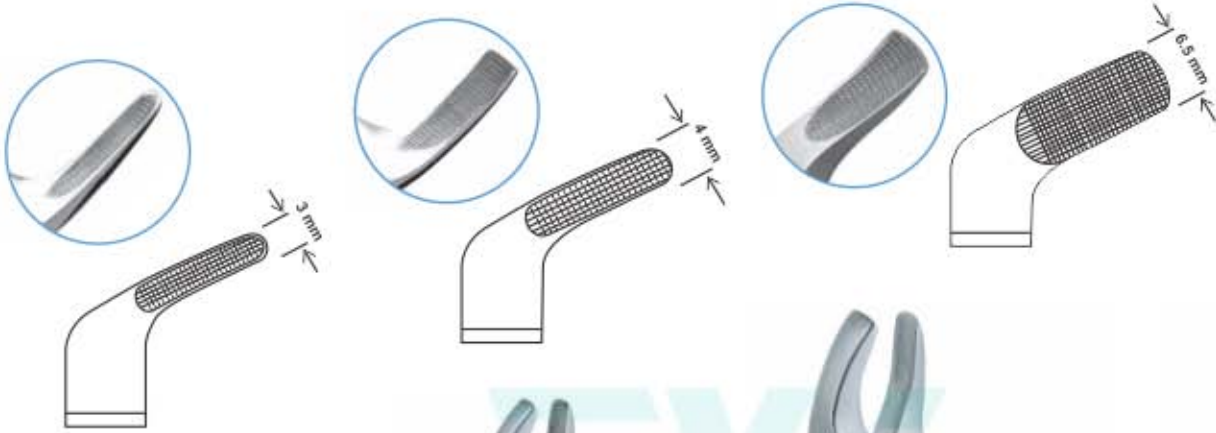

TW1-230
Meissner
Extracting Forceps
S1



TW1-231
Meissner
Extracting Forceps
M2



TW1-232
Meissner
Extracting Forceps
L3



TW1-233
Comellas Forceps

EXTRACTING FORCEPS SET



- Извлечение щипцов
- Ensemble de pinces d'extraction
- Zange sammeln
- Витягуючий комплект щипців
- Extracción del conjunto de fórceps
- استخراج ملقط مجموعة



TW1-234

Extracting Forceps
Set of 10 Pieces
Extracting Forceps Fig. 2
Extracting Forceps Fig. 7
Extracting Forceps Fig. 13
Extracting Forceps Fig. 17
Extracting Forceps Fig. 18
Extracting Forceps Fig. 22
Extracting Forceps Fig. 33
Extracting Forceps Fig. 51A
Extracting Forceps Fig. 67A
Extracting Forceps Fig. 79



TW1-235

Extracting Forceps
Set of 10 Pieces
Extracting Forceps Fig. 2
Extracting Forceps Fig. 7
Extracting Forceps Fig. 13
Extracting Forceps Fig. 17
Extracting Forceps Fig. 18
Extracting Forceps Fig. 22
Extracting Forceps Fig. 33
Extracting Forceps Fig. 51A
Extracting Forceps Fig. 67A
Extracting Forceps Fig. 79



- Извлечение щипцов
- Ensemble de pinces d'extraction
- Zange sammeln
- Витягуючий комплект щипців
- Extracción del conjunto de fórceps
- استخراج ملقط مجموعة



TW1-236

- Extracting Forceps
Set of 13 Pieces
- Extracting Forceps Fig. 2
 - Extracting Forceps Fig. 7
 - Extracting Forceps Fig. 13
 - Extracting Forceps Fig. 17
 - Extracting Forceps Fig. 18
 - Extracting Forceps Fig. 22
 - Extracting Forceps Fig. 33
 - Extracting Forceps Fig. 51A
 - Extracting Forceps Fig. 67A
 - Extracting Forceps Fig. 79
 - Extracting Forceps Fig. 86C
 - Extracting Forceps Fig. 89
 - Extracting Forceps Fig. 90



TW1-237

- Extracting Forceps Children Pattern
Set of 10 Pieces
- Extracting Forceps Fig. 13S
 - Extracting Forceps Fig. 22S
 - Extracting Forceps Fig. 30S
 - Extracting Forceps Fig. 33S
 - Extracting Forceps Fig. 37
 - Extracting Forceps Fig. 38
 - Extracting Forceps Fig. 39
 - Extracting Forceps Fig. 39L
 - Extracting Forceps Fig. 39R
 - Extracting Forceps Fig. 51S



EXTRACTING FORCEPS KITS



- Извлечение щипцов
- Kits de forceps d'extracteurs
- Zangen ausziehen
- Витягуючі комплекти щипців
- Extracción de kits de fórceps
- استخراج ملقط اطقم



TW1-238
Set of 37 Pcs

01 - Extracting Forceps	Fig.1	1
02 - Extracting Forceps	Fig.7	1
03 - Extracting Forceps	Fig.13	1
04 - Extracting Forceps	Fig.17	1
05 - Extracting Forceps	Fig.18	1
06 - Extracting Forceps	Fig.18A	1
07 - Extracting Forceps	Fig.19	1
08 - Extracting Forceps	Fig.20	1
09 - Extracting Forceps	Fig.22	1
10 - Extracting Forceps	Fig.29	1
11 - Extracting Forceps	Fig.33	1
12 - Extracting Forceps	Fig.51	1
13 - Extracting Forceps	Fig.51A	1
14 - Extracting Forceps	Fig.67A	1
15 - Extracting Forceps	Fig.79	1
16 - Extracting Forceps	Fig.136	1
17 - Extracting Forceps	Fig.137	1
18 - Extracting Forceps	Fig.53 L	1
19 - Extracting Forceps	Fig.53 R	1
20 - Extracting Forceps	Fig.65	1
21 - Root Elevators	Fig.1B	1
22 - Root Elevators	Fig.3B	1
23 - Root Elevators	Fig.5B	1
24 - Root Elevators	Fig.4B SA Apexo	1
25 - Root Elevators	Fig.5B SA Apexo	1
26 - Cotton Tweezers		1
27 - Mouth Mirrors With Handles	Fig.5	1
28 - Explorers		1
29 - Cement Spatulas		1
30 - Filling Instruments		1
31 - Filling Instruments		1
32 - Filling Instruments		1
33 - Filling Instruments		1
34 - Gum Scissors		1
35 - Excavators		1
36 - Bone Curettes		1
37 - Dental Aspirated Syringes		1



TW1-239 Available in Gold Coated Set of 25 Pcs
TW1-240 Available in Polish Set of 25 Pcs

01 - Extracting Forceps	Fig.13	1
02 - Extracting Forceps	Fig.17	1
03 - Extracting Forceps	Fig.18	1
04 - Extracting Forceps	Fig.19	1
05 - Extracting Forceps	Fig.20	1
06 - Extracting Forceps	Fig.22	1
07 - Extracting Forceps	Fig.29	1
08 - Extracting Forceps	Fig.33	1
09 - Extracting Forceps	Fig.51	1
10 - Extracting Forceps	Fig.51A	1
11 - Extracting Forceps	Fig.67A	1
12 - Extracting Forceps	Fig.79	1
13 - Root Elevators	Fig.1B	1
14 - Root Elevators	Fig.3B	1
15 - Root Elevators	Fig.4B SA Apexo	1
16 - Root Elevators	Fig.5B SA Apexo	1
17 - Cotton Tweezers		1
18 - Mouth Mirrors With Handles		1
19 - Explorers		1
20 - Cement Spatulas		1
21 - Filling Instruments		1
22 - Filling Instruments		1
23 - Filling Instruments		1
24 - Excavators		1
25 - Dental Aspirated Syringes		1

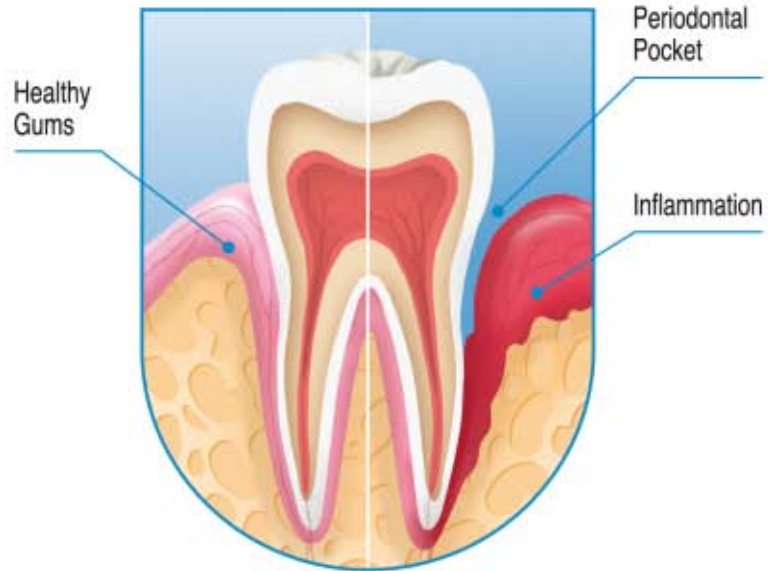

HANDLES FOR ROOT ELEVATORS POINTS A, B, C, D



Truewin Dental Root Elevators

To look at one of these instruments you might mistake it for a narrow screwdriver.

That's because just like one an elevator has a handle and then a specially designed "blade" or tip portion.

How they're used.

The tip of an elevator is designed to be wedged into the ligament space between a tooth and its surrounding bone (as shown in our animation).

As the elevator is forced into and twisted around in this space, the tooth is rocked around and pressed against the walls of its socket.

This helps to both expand the shape of the socket and separate the tooth from its ligament.

As this work is continued, the tooth gradually becomes more and more mobile.

In some cases, the dentist may be able to completely remove the tooth just using their elevator.

If not, they will choose a point where they feel they have accomplished as much as they can with it and will then switch to using extraction forceps.

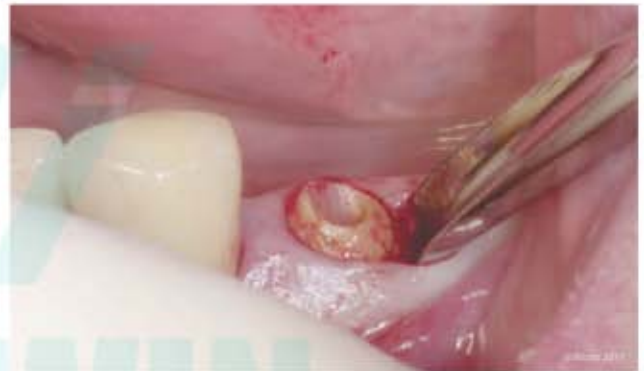

- Элеватор корневой экстракционный
- Elevator coronevii ekstraktsionnyy
- Elévateurs à racines
- Elevadores para raíces
- Wurzelheber
- المعصاع الجذر

Apexo Root Elevators



Apexo Root Elevator



TW2-01
Apexo
2.5x9mm
Straight



TW2-02
Apexo
2.7x9mm
Straight



TW2-03
Apexo
3.0x9mm
Straight



TW2-04
Apexo
2.5x9mm
Curved



TW2-05
Apexo
3.0x9mm
Curved



TW2-06
Seldin
3.0x14mm
Straight

FUNCTION: To loosen tooth or root from bony socket prior to placement of the extraction forceps.



Luxator Root Elevators



Luxator Root Elevator



TW2-07
Luxator
3mm
straight



TW2-08
Luxator
3mm
curved



TW2-09
Luxator
4mm
straight



TW2-10
Luxator
4mm
curved



TW2-11
Luxator
5mm
straight



TW2-12
Luxator
5mm
curved

ROOT ELEVATOR



- Элеватор корневой экстракционный
- Elévateurs à racines
- Wurzelheber
- Elevator coronevii ekstraktsionnyy
- Elevadores para raices
- المعصاع الجذر

Apexo Root Elevators



Apexo
Root Elevator



TW2-13
Apexo
2.5x9mm
Straight

TW2-14
Apexo
2.7x9mm
Straight

TW2-15
Apexo
3.0x9mm
Straight

TW2-16
Apexo
2.5x9mm
Curved

TW2-17
Apexo
3.0x9mm
Curved

TW2-18
Seldin
3.0x14mm
Straight

Luxator Root Elevators



Luxator
Root Elevator



TW2-19
Luxator
3mm
straight

TW2-20
Luxator
3mm
curved

TW2-21
Luxator
4mm
straight

TW2-22
Luxator
4mm
curved

TW2-23
Luxator
5mm
straight

TW2-24
Luxator
5mm
curved



ROOT ELEVATOR

- Элеватор корневой экстракционный
- Elévateurs à racines
- Wurzelheber
- Elevator corneviu extracționii
- Elevadores para raíces
- المعصاع الجذر

Bein Root Elevators

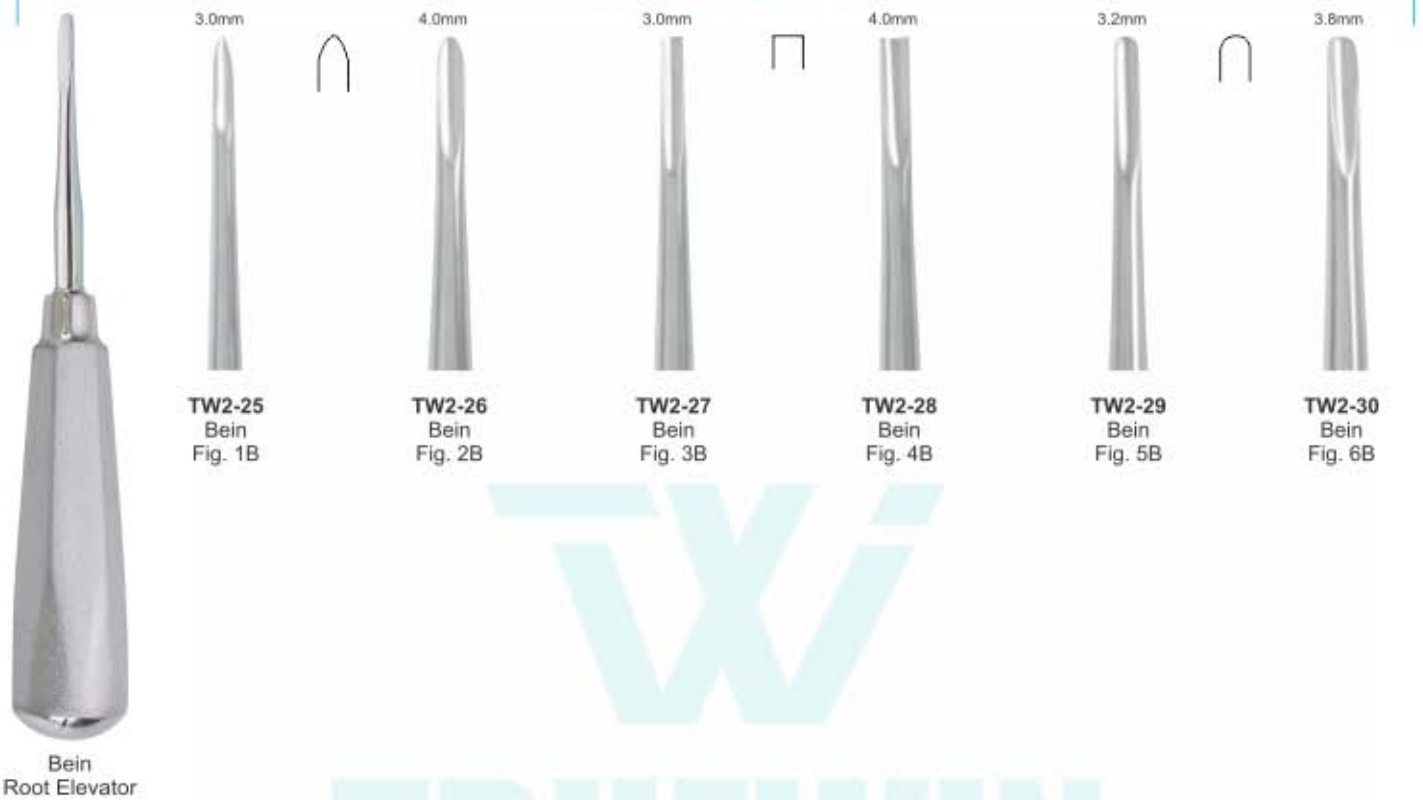

Seldin Root Elevators



- Элеватор корневой экстракционный
 - Elévateurs à racines
 - Wurzelheber
- Elevator corneviu extracționiu
 - Elevadores para raices
 - المصاعد الجذر

Bein Root Elevators



Seldin Root Elevators



- Элеватор корневой экстракционный
- Elevator cornevier ekstrakçionnyy
- Elévateurs à racines
- Elevadores para raices
- Wurzelheber
- المعصاع الجذر

Flohr Root Elevators



TW2-51
Fig. 1F
Str.

Flohr Root Elevators



TW2-52
Fig. 2F
Left
Flohr



TW2-53
Fig. 3F
Right
Flohr

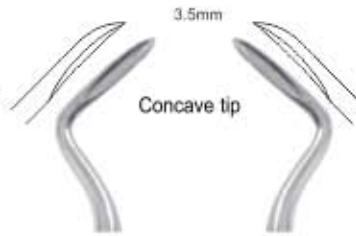

TW2-54
Fig. 4B SA
Schmeckeblie
Apexo



TW2-55
Fig. 5B SA
Schmeckeblie
Apexo



TW2-56
Fig. 4 SA
Schmeckeblie
Apexo



TW2-57
Fig. 5 SA
Schmeckeblie
Apexo

Coupland Root Elevators



TW2-58
Coupland No.1



TW2-59
Coupland No.2



TW2-60
Coupland No.3

Apical Root Elevators



Apical
Root Elevator



TW2-61
Apical 301



TW2-62
Apical 302
(Left)



TW2-63
Apical 303
(Right)



Apical
Root Elevator



TW2-64
Apical 301



TW2-65
Apical 302



TW2-66
Apical 303



TW2-67
Apical 302A



TW2-68
Apical 303A



TW2-69
Fig. 304

ROOT ELEVATOR



- Элеватор корневой экстракционный
- Elévateurs à racines
- Wurzelheber
- Elevator coronev ekstraktsionnyy
- Elevadores para raices
- المعاصر الجذر

Laxutor Root Elevators

Long Type



Laxutor
Root Elevator



TW2-70
Laxutor
1.5mm
Str.



TW2-71
Laxutor
2mm
Str.



TW2-72
Laxutor
3mm
Str.



TW2-73
Laxutor
5mm
Str.



TW2-74
Laxutor
3mm
Cvd.

FUNCTION:

To loosen tooth or root from bony socket prior to placement of the extraction forceps.



TW2-75
Laxutor
5mm
Cvd.



TW2-76
Laxutor
3mm
Upper
Angle



TW2-77
Laxutor
3mm
Double
Angle



TW2-78
Laxutor
3mm
Str.



TW2-79
Laxutor
5mm
Str.

- Элеватор корневой экстракционный
- Elévateurs à racines
- Wurzelheber
- Elevator coronevii ekstraktsionnyy
- Elevadores para raices
- المصاعد الجذر

Cryer Root Elevators



Cryer
Root Elevator



TW2-80
Cryer
Fig. 44

TW2-81
Cryer
Fig. 45



TW2-82
Cryer
Fig. 25

TW2-83
Cryer
Fig. 26



TW2-84
Cryer
Fig. 31

TW2-85
Cryer
Fig. 32

Miller Root Elevators



TW2-86
Miller 1



TW2-87
Miller 2



TW2-88
Miller 3
Left



TW2-89
Miller 3
Right

ROOT ELEVATOR



- Элеватор корневой экстракционный
- Elévateurs à racines
- Wurzelheber
- Elevator cornevier ekstrakčníj
- Elevadores para raíces
- المصاعد الجذر

Lindo Levian Root Elevators



Lindo Levian Root Elevator



Friedmann Roots Elevator



Friedmann Roots Elevator



Heidbrink Root Elevators

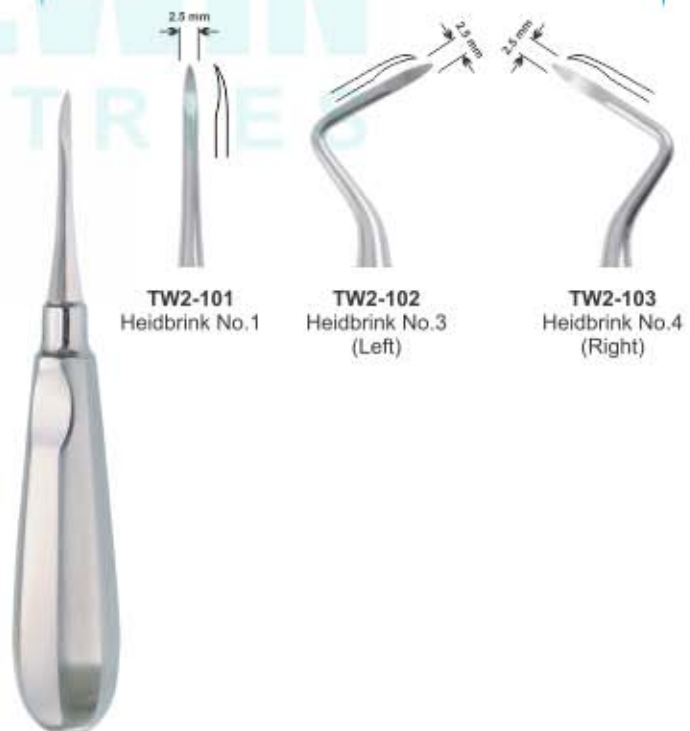

Heidbrink Root Elevator

- Элеватор корневой экстракционный
 - Elévateurs à racines
 - Wurzelheber
- Elevator cornevier ekstrakční
 - Elevadores para raíces
 - المعصاع الجذر

Mesial & Distal Root Elevators



Root Elevators



Apexo Root Elevators



- Elevator корневой экстракционный
- Elévateurs à racines
- Wurzelheber
- Elevator corneviu extracționii
- Elevadores para raíces
- المعصاع الجذر

Wisdom Roots Elevator



TW2-115
Wisdom
for 18 and 38

TW2-116
Wisdom
for 28 and 48

Bayonet Roots Elevator Set



TW2-117
Left

TW2-118
Right

TW2-119
bayonet

TW2-120
Curved

TW2-121
Straight

Roots Elevator



TW2-122
Fig. 60

TW2-123
Fig. 61

TW2-124
Fig. 62

TW2-125
Fig. 63

Luxier Roots Elevator



TW2-126
Luxier
3mm, Straight

TW2-127
Luxier
3mm, Curved

TW2-128
Luxier
5mm, Stright

TW2-129
Luxier
3mm, Angular

- Элеватор корневой экстракционный
- Elévateurs à racines
- Wurzelheber
- Elevator corneviu extracționii
- Elevadores para raíces
- المعصاع الجذر

Hylin Roots Elevator



Coleman Root Elevator



Molars Roots Elevator

Schlemmer Roots Elevator

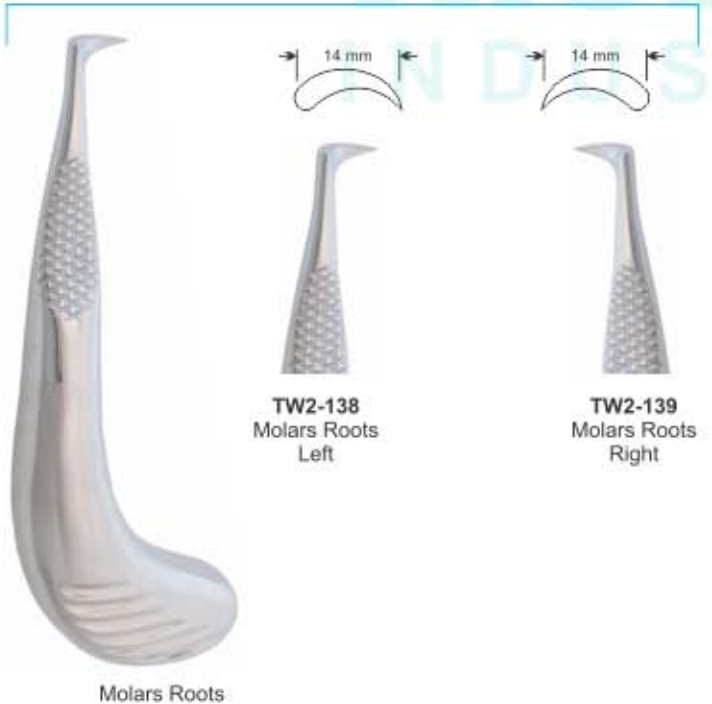

ROOT ELEVATOR



- Elevator корневой экстракционный
- Elévateurs à racines
- Wurzelheber
- Elevator корневий екстракційний
- Elevadores para raíces
- المصاعد الجذر

Medan Roots Elevator



Medan Roots Elevator

TW2-143 Bein 2.5mm	TW2-144 Bein 3mm Flat	TW2-145 Bein 3mm Round	TW2-146 Bein 3.5mm	TW2-147 Flohr 3.5mm (Left)	TW2-148 Flohr 3.5mm (Right)	TW2-149 Cryer 10mm (Left)	TW2-150 Cryer 10mm (Right)
	TW2-151 Seldin 4L (Left)	TW2-152 Seldin 4R (Right)		TW2-153 Seldin 1L (Left)	TW2-154 Seldin 1R (Right)		
							TW2-155 Seldin

Roots Elevator



TW2-156 Bein 2.5mm	TW2-157 Bein 3mm Flat	TW2-158 Bein 3mm Round	TW2-159 Bein 3.5mm	TW2-160 Flohr 3.5mm (Left)	TW2-161 Flohr 3.5mm (Right)	TW2-162 Cryer 10mm (Left)	TW2-163 Cryer 10mm (Right)
	TW2-164 Seldin 4L (Left)	TW2-165 Seldin 4R (Right)		TW2-166 Seldin 1L (Left)	TW2-167 Seldin 1R (Right)		
							TW2-168 Seldin

- Elevator корневой экстракционный
- Elévateurs à racines
- Wurzelheber
- Elevator корневий экстракційний
- Elevadores para raíces
- المعصاع الجذر



Root Elevators



TW2-169
Bein
2mm
round

TW2-170
Bein
3mm
round

TW2-171
Bein
4mm
round

TW2-172
Bein
2mm
Flat

TW2-173
Bein
3mm
Flat

TW2-174
Bein
4mm
Flat

TW2-175
White
4mm

TW2-176
White
4mm



TW2-177
Berten
5mm
Lower roots



TW2-178
3mm



TW2-179
3mm



TW2-180
3mm



TW2-181
3mm



TW2-183
Flohr
3mm



TW2-184
Flohr
3mm
Flat



TW2-185
Flohr
3mm
Flat



TW2-186
Cryer
10mm



TW2-187
Cryer
10mm



TW2-182
Flohr 3mm

FUNCTION: To loosen tooth or root from bony socket prior to placement of the extraction forceps.



- Элеватор корневой экстракционный
- Elevator corneviy ekstraktsionnyy
- Elévateurs à racines
- Elevadores para raíces
- Wurzelheber
- المعصاع الجذر

Kopp Roots Elevator



TW2-188
Fig. 1
Kopp
3.6mm
Upper Roots



TW2-189
Fig. 2
Kopp
3.6mm
Upper Roots



TW2-190
Fig. 3
Kopp
4.2mm
Upper Roots



TW2-191
Fig. 4
Kopp
4.2mm
Upper Roots



TW2-192
Fig. 1
Kopp
3.6mm
Lower Roots



TW2-193
Fig. 2
Kopp
3.6mm
Lower Roots



TW2-194
Fig. 3
Kopp
4.2mm
Lower Roots



TW2-195
Fig. 4
Kopp
4.2mm
Lower Roots

- Elevator корневой экстракционный
- Elévateurs à racines
- Wurzelheber
- Elevator корневий екстракційний
- Elevadores para raíces
- المعصاع الجذر

Kopp Roots Elevator



TW2-196
Kopp
Right

TW2-197
Kopp
Left

Heber Roots Elevator



TW2-198
Heber
Bayonet

TW2-199
Heber
Bayonet

Bein Roots Elevator



TW2-200
Bein
3mm

TW2-201
Bein
4mm

Bein Roots Elevator



TW2-203
2mm
straight
serrated

TW2-204
3mm
straight

TW2-205
4mm
Curved

TW2-207
2mm
straight
serrated

TW2-208
3mm
straight

TW2-209
4mm
Curved

TW2-211
2mm
straight
serrated

TW2-212
3mm
straight

TW2-213
4mm
Curved

TW2-202
Bein
2mm, curved
serrated

TW2-206
Bein
2mm, curved
serrated

TW2-210
Bein
2mm, curved
serrated

ROOT ELEVATOR



- Элеватор корневой экстракционный
- Elévateurs à racines
- Wurzelheber
- Elevator cornevier ekstrakčný
- Elevadores para raíces
- المصاعد الجذر

W. Barry Roots Elevator



W. Barry
Fig. 1
(125mm)



TW2-214
W. Barry
Fig. 1



TW2-215
W. Barry
Fig. 2



TW2-216
W. Barry
Fig. 3



TW2-217
W. Barry
Fig. 4

Winter Roots Elevator



Winter
Fig. 1L
(125mm)



TW2-218
Winter
Fig. 1L



TW2-219
Winter
Fig. 1R



TW2-220
Winter
Fig. 11L



TW2-221
Winter
Fig. 11R



TW2-222
Winter
Fig. 12L



TW2-223
Winter
Fig. 12R

Pott Roots Elevator



TW2-224
Winter
Fig. 1L



TW2-225
Winter
Fig. 1R



TW2-226
Lecluse
bayonet



TW2-227
Pott
Left



TW2-228
Pott
Right

- Elevator корневой экстракционный
- Elévateurs à racines
- Wurzelheber
- Elevator корневий екстракційний
- Elevadores para raíces
- المعصاع الجذر

Heidbrink Roots Elevator



TW2-229 Heidbrink Straight
TW2-230 Heidbrink Left
TW2-231 Heidbrink Right
TW2-232 Heidbrink Straight
TW2-233 Heidbrink Left
TW2-234 Heidbrink Right

Syndesmotomes Roots Elevator



TW2-235 Straight
TW2-236 Left
TW2-237 Right

Periotome Roots Elevator

Syndesmotomes



TW2-238 Periotome 2.1mm Straight
TW2-239 Periotome 2.6mm Straight
TW2-240 Periotome 2.1mm Angular
TW2-241 Periotome 2mm Curved
TW2-242 Periotome 2.0mm
TW2-243 Periotome 2.5mm
TW2-244 Periotome 3.0mm
TW2-245 Periotome 4.0mm

ROOT ELEVATOR



- Элеватор корневой экстракционный
 - Elévateurs à racines
 - Wurzelheber
- Elevator corneviu extracționii
 - Elevadores para raices
 - المعصاع الجذر

FUNCTION: To loosen small root fragments from bony socket



- Элеватор корневой экстракционный
- Elévateurs à racines
- Wurzelheber
- Elevator corneviu extracționiu
- Elevadores para raices
- المعصاع الجذر



TW2-255
Fig. 1S
(Straight 1mm)



TW2-256
Fig. 2S
(Straight 2mm)



TW2-257
Fig. 3S
(Straight 3mm)



TW2-258
Fig. 5S
(Straight 5mm)



TW2-259
Fig. 3C
(Curved 3mm)



TW2-260
Fig. 5C
(Curved 5mm)



TW2-261
Fig. 3CA
(Curved Angle 3mm)



TW2-262
Fig. 3IC
(Inverted Curved 3mm)



TW2-263
Fig. DE 3
(Dual Edge 3mm / 1.5mm)



TW2-264
Fig. DE 5
(Dual Edge 5mm / 3mm)

ROOT ELEVATOR



- Элеватор корневой экстракционный
- Elevator coronevii ekstraktsionnyy
- Elévateurs à racines
- Elevadores para raíces
- Wurzelheber
- المعصاع الجذر

TW2-265 Blue Plasma Coated PDL Elevators Set of 7 Pcs



Area: distal



Area: mesial

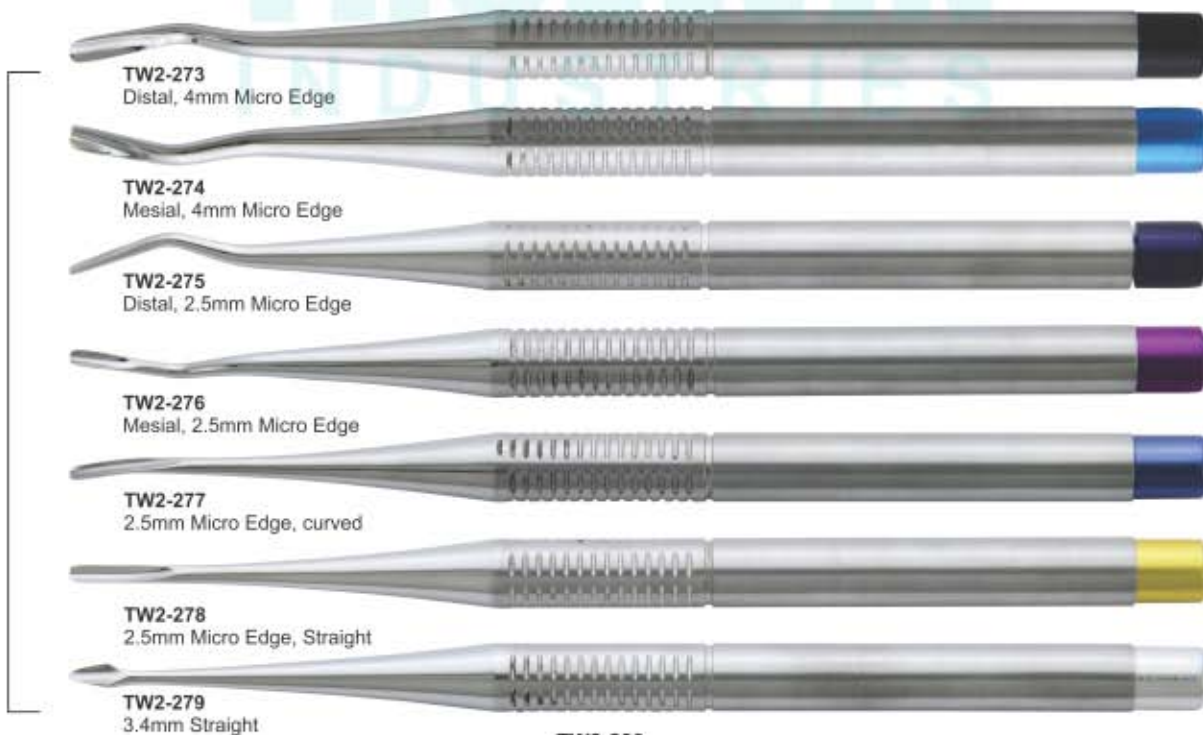

TW2-280 PDL Elevators Set of 7 Pcs

- Элеватор корневой экстракционный
- Elévateurs à racines
- Elevator coronevii ekstraktsionnyy
- Elevadores para raices

PDL ELEVATORS

Delicate Arrow tip



TW2-281
4,0mm
straight

TW2-282
4,0mm
curved

Luxivators straight
atraumatic luxation of the tooth



TW2-283
2,5mm
straight

TW2-284
3,5mm
straight

TW2-285
4,5mm
straight

Luxivators curved
atraumatic luxation of the tooth



TW2-286
2,5mm
curved

TW2-287
3,5mm
curved

TW2-288
4,5mm
curved



Area: approximal (mesial, distal)



for loosening of the tooth

TW2-289
PDL Elevators
Set of 8 Pcs

Truewin Dental Hand Instruments

The types of hand instruments can be categorized based on their function:

- Examining the mouth and teeth
- Scaling or professional cleaning of teeth
- Cutting teeth and removing cavities
- Placing and condensing filling materials
- Carving and finishing dental fillings
- Miscellaneous types
- Instruments used for examining the mouth and teeth

Mouth mirrors are used to examine the condition of the teeth and mouth, as well as to retract the tongue and cheeks upon examination.

Probes— There are many probes available but the main types are the straight probe, Briault probe and periodontal probe.

The straight probe is sharp and it is used to examine cavities in the dentine region as well as to check the margins of restorations or fillings.

The Briault probe is also sharp and it is used to detect the junction between the enamel and dentine. Briault can also be used to detect tartar hidden in the gum pockets.

A periodontal probe can be used to measure the depth of the gum pockets and for other measurements. Instruments for cutting and scraping tissues and deposits

Scalers remove tartar (calculus) on the tooth surface as well as those hidden in the gum pockets. They can also be used to remove other surface deposits and temporary crowns.

Excavators are used to remove softened dentine and temporary fillings. The back of the blade can also be used for placing linings between filling materials. Sometimes excavators can be used for carving metal or amalgam fillings.

Chisels are used to remove unsupported enamel during cavity preparation. Unsupported enamel can be harmful for it can compromise the longevity of the filling if not removed.

Hatchets and hoes have similar purposes to chisels. Instruments used for placing and condensing filling materials Plastic instruments convey and shape filling materials and are usually flat blades that do not use heavy pressure.

Some instruments have rounded ends for shaping and burnishing the surfaces of fillings. Plastic instruments are usually made of stainless steel for most materials though there are also thin Teflon-coated or titanium nitride instruments which are non-stick for composite fillings. **Condensers or pluggers** are used for compressing and forming filling materials. Heavy pressure is applied on use therefore these instruments are usually used for metal or amalgam fillings. Instruments used for carving and finishing fillings Carving and finishing instruments have sharp or semi-sharp blades of various shapes. They are used to carve materials by cutting and scraping.





VALUED BUYERS

Compare our scalers and curettes with the best in the industry and you will immediately recognize we are equal in every way but one... price. Note the deep precision knurling for better tactile feel. The same high-grade stainless steel tips, the same light weight (under 20 grams) for less hand fatigue, the same professional craftsmanship, and surpassing the highest industry standards. Of course, any manufacturer can make these claims, but we guarantee and certify ours. We regularly manufacture below articles in showing handles & pattern A,B,C,D,E,F,G,H,I & J for better grip & perfection. We are also fully equipped & capable to develop these instruments as per your own specific requirements & demands in materials, sizes, shapes and patterns.



A



B



C



D



E



F



G



H



I



J

MOUTH MIRRORS



- زعكان
- Espejos de la boca
- Mundspiegel

- дзеркан
- Mirrors à la bouche
- مرايا الفم



Plain



TW3-01
Fig. 3
Ø20mm

TW3-02
Fig. 4
Ø22mm

TW3-03
Fig. 5
Ø24mm

TW3-04
Fig. 6
Ø26mm



Cone-Socket Plain



TW3-05
Fig. 3
Ø20mm

TW3-06
Fig. 4
Ø22mm

TW3-07
Fig. 5
Ø24mm



Magnifying



TW3-08
Fig. 3
Ø20 mm

TW3-09
Fig. 4
Ø22 mm

TW3-10
Fig. 5
Ø24 mm



Cone-Socket Magnifying



TW3-11
Fig. 3
Ø20mm

TW3-12
Fig. 4
Ø22mm

TW3-13
Fig. 5
Ø24mm

- Ручки для зеркал
- Manches pour miroirs à bouche
- Mundspiegelgriffe
- Ручки для дзеркал
- Mangos para espejos de boca
- مقابض لمرآة الفم



Rhodium

Cone-Socket Rhodium



TW3-14
Fig. 3
Ø20mm

TW3-15
Fig. 4
Ø22mm

TW3-16
Fig. 5
Ø24 mm

TW3-17
Fig. 3
Ø20mm

TW3-18
Fig. 4
Ø22mm

TW3-19
Fig. 5
Ø24mm



Cone-Socket

TW3-20
Mirror Handle

TW3-21
Mirror Handle

TW3-22
Hollow Mirror
Handle

TW3-23
Hollow

TW3-24
Hollow

TW3-25
Mirror Handle
Stem with
Rule 35mm

TW3-26
Cone-socket
Solid

TW3-27
Cone-socket
Solid

TW3-28
Cone-socket
Hollow

TWEEZERS



- Пинцеты
- Précelles - Brucelles
- Zahnpinzetten

- Пинцети
- Pinzas para algodón
- ملاقط



TW3-29
London College
150mm



TW3-30
Meriam
160mm



TW3-31
Semken Taylor
125mm
Straight



TW3-32
Semken Taylor
125mm
Curved



TW3-33
Semken Taylor
125mm
1x2 Straight



TW3-34
Semken Taylor
125mm
1x2 Curved



TW3-35
Flagg
150mm



TW3-36
Meriam
160mm



TW3-37
Amsterdam
155mm



TW3-38
Atraumatic
150mm
Straight



TW3-39
Atraumatic
150mm
Angled



TW3-40
Atraumatic
175mm



TW3-41
Gilles
150mm 1x2



TW3-42
Perry
130mm
Curved



TW3-43
College with Lock
150mm
Angled



TW3-44
College Pliers
with Lock
Grooved
150mm

- Пинцеты
- Précelles - Brucelles
- Zahnpinzetten

- Пинцети
- Pinzas para algodón
- ملاقط



TW3-45
Adson-TC
120mm



TW3-46
Adson-TC
120mm 1x2



TW3-47
Adson-TC
150mm 1x2



TW3-48
Adson
120mm



TW3-49
Adson
120mm 1x2



TW3-50
Adson
150mm 1x2



TW3-51
Adson Brown
120mm



TW3-52
Crane Kaplan
150mm



TW3-53 115mm
TW3-54 140mm
Dressing Forceps



TW3-55 115mm
TW3-56 140mm
Tissue Forceps



TW3-57
Hemingway
150mm



TW3-58
Crane Kaplan
150mm



TW3-59
Crane Kaplan
150mm



TW3-60
Gerald
175mm

SOLDERING PLIERS - TWEEZERS & SPLINTER FORCEPS



- Пинцеты для удаления осколков
- Pincettes pour soudure - Pincettes et pincettes à écharde
- Löt-Zange - Pinzette & SplinterZange
- Пинцети для видалення осколків
- Alicates Soldadura - Pinzas y pinzas de Splinter
- لحام كمانشة - ملاقط منشقة العلقظ



TW3-61
Soldering Pliers
160mm



TW3-62
Soldering Pliers
160mm



TW3-63
Posigrip Articulating
Paper Forceps
150mm



TW3-64
Standard Articulating
Paper Forceps, Economy Grade
150mm



TW3-65
Miller
150mm
Curved



TW3-66
125mm



TW3-67
125mm



TW3-68
115mm



TW3-69
125mm



TW3-70
125mm



TW3-71
Stieglitz Splinter Forceps
140mm 90°



TW3-72
Peet
115mm

- Комплект для обследования
- Ensemble d'examen
- Prüfungssatz
- Экзаменаційний набір
- Conjunto de examen
- مجموعة الفحص

TW3-73
Examination kit Set of 3 Pieces



TW3-74
Examination Set of 4 Pieces



TW3-75
Initial examination Set of 3 Pieces



TW3-76
Initial examination Set of 3 Pieces



TW3-77
Initial examination Set of 3 Pieces



- Зонды
- Sondes
- Zahnsonden
- Зонди
- Sondas
- المستكشفين

Single Ended Probe Solid Handle 5.5mm, Length 150mm



Fig. 2
Normal Handle

Single Ended Probe Hollow Handle 8.5mm Length 150mm

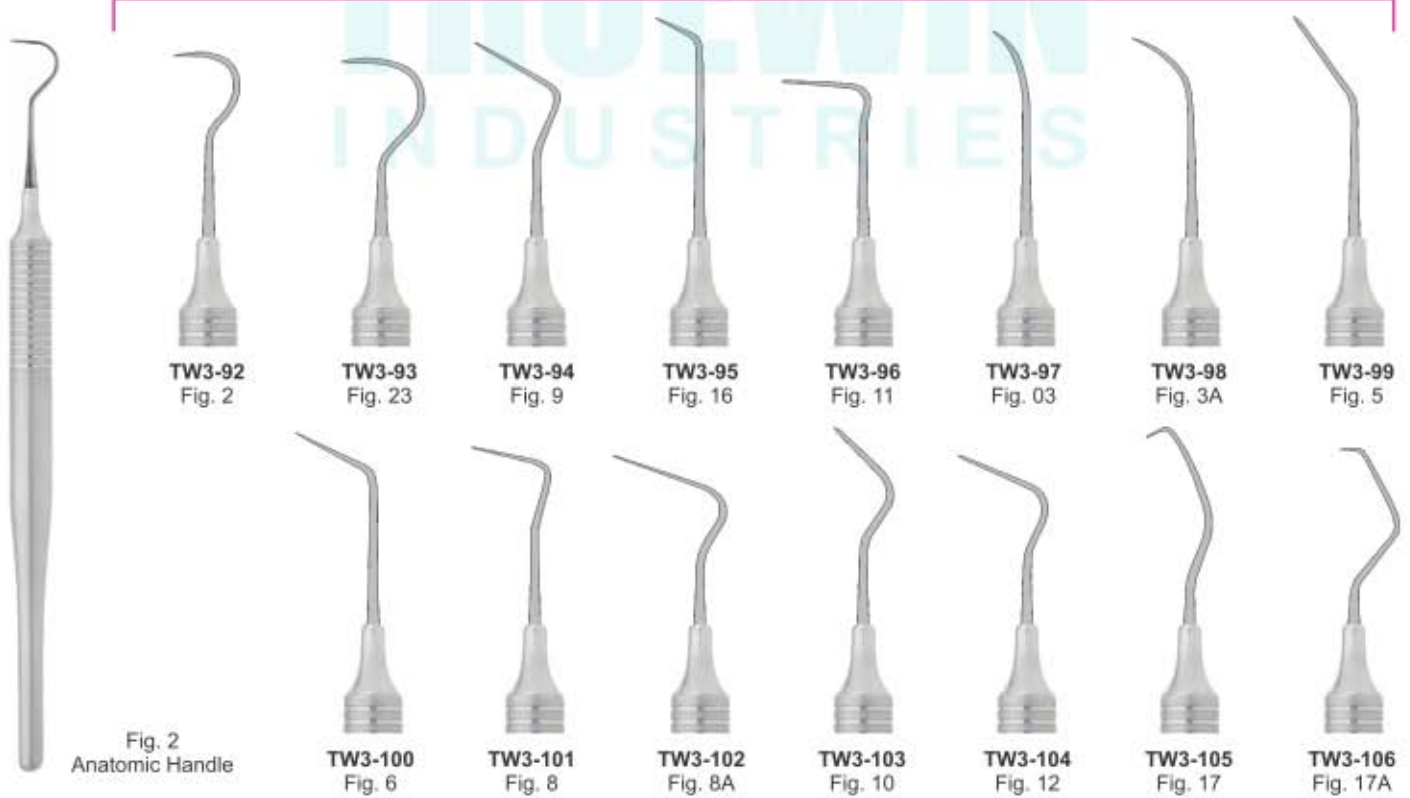
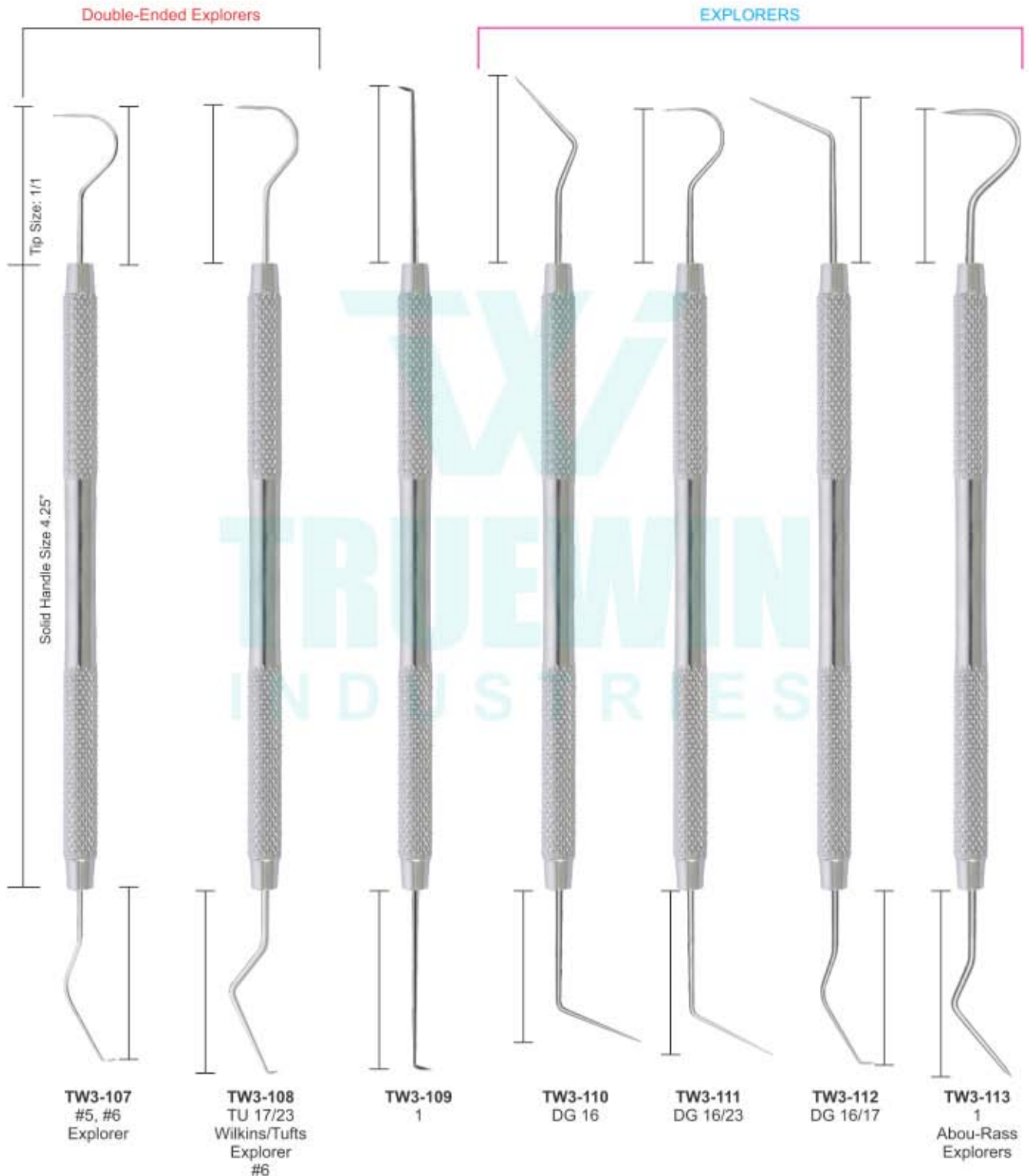

Fig. 2
Anatomic Handle

- Зонды
 - Sondes
 - Zahnsonden
- Зонди
 - Sondas
 - المستكشفين

EXPLORERS INSTRUMENTS SOLID HANDLE 5.5MM, LENGTH 170MM



EXPLORERS



- Зонды
 - Sondes
 - Zahnsonden
- Зонди
 - Sondas
 - المستكشفين

EXPLORERS INSTRUMENTS HOLLOW HANDLE 9.5MM LENGTH 150MM Probes Single Ended



TW3-115
Perio Probe Williams

TW3-116
Perio Probe WHO

TW3-117
Perio Probe 11

TW3-118
Perio Probe 12

Probes Double Ended 5.5mm, Length 170mm



TW3-114
23/UNC1
university of north
carolina

TW3-119
Goldman Fox
Fig. 17

TW3-120
University
of Michigan
Fig. 17

TW3-121
Williams
Fig. 17

TW3-122
Goldman Fox
Fig. 16

TW3-123
University
of Michigan
Fig. 16

TW3-124
Williams
Fig. 16

- Зонды
 - Sondes
 - Zahnsonden
- Зонди
 - Sondas
 - المستكشفين

Pointed Probes Single Ended Handle 5.5mm, Length 150mm



Pointed Probes Double Ended Handle 5.5mm, Length 170mm



- Инструменты пародонтологические
 - Instruments pour la parodontologie
 - Instrumente für die Parodontologie
- Инструменти пародонтологічні
 - instrumentos para periodoncia
 - الصوك اللثة

TW3-137

PERIODONTAL SET OF 10 PIECES SOLID HANDLE 5.5MM LENGTH 170MM



TW3-138
Mouth Mirror

TW3-139
EXP,23/17-A

TW3-140
Exavators

TW3-141
Filling
Instruments

TW3-142
EXP,23/CP-18

TW3-143
EXP,23/CP-QW

TW3-144
EXP,23/CP-11

TW3-145
EXP,23/CP-10

TW3-146
EXP,23/CP-12

TW3-147
EXP,23/CP-11.5-B

- Зонды
 - Sondes
 - Zahnsonden
- Зонди
 - Sondas
 - المستكشفين

TW3-148

WILLIAM PROBE SET DOUBLE ENDED WITH HOLLOW HANDLE 9.5MM, LENGTH 170MM
PLASMA COATED HANDLE

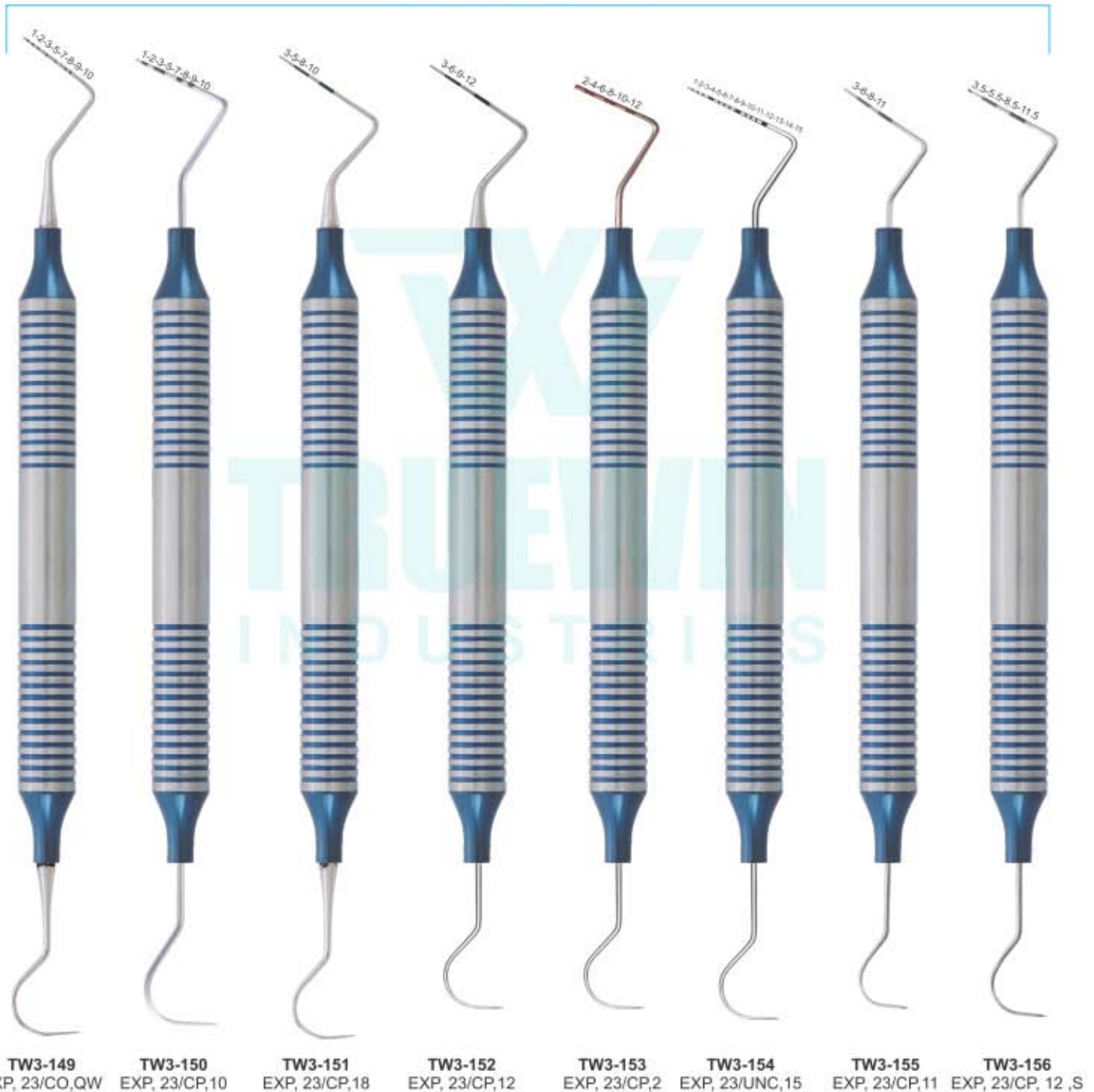

TW3-149
EXP, 23/CO,QW

TW3-150
EXP, 23/CP,10

TW3-151
EXP, 23/CP,18

TW3-152
EXP, 23/CP,12

TW3-153
EXP, 23/CP,2

TW3-154
EXP, 23/UNC,15

TW3-155
EXP, 23/CP,11

TW3-156
EXP, 23/CP, 12 ,S

- Зонды
 - Sondes
 - Zahnsonden
- Зонди
 - Sondas
 - المستكشفين

EXPLORERS INSTRUMENTS
SOLID HANDLE 5.5MM, LENGTH 170MM

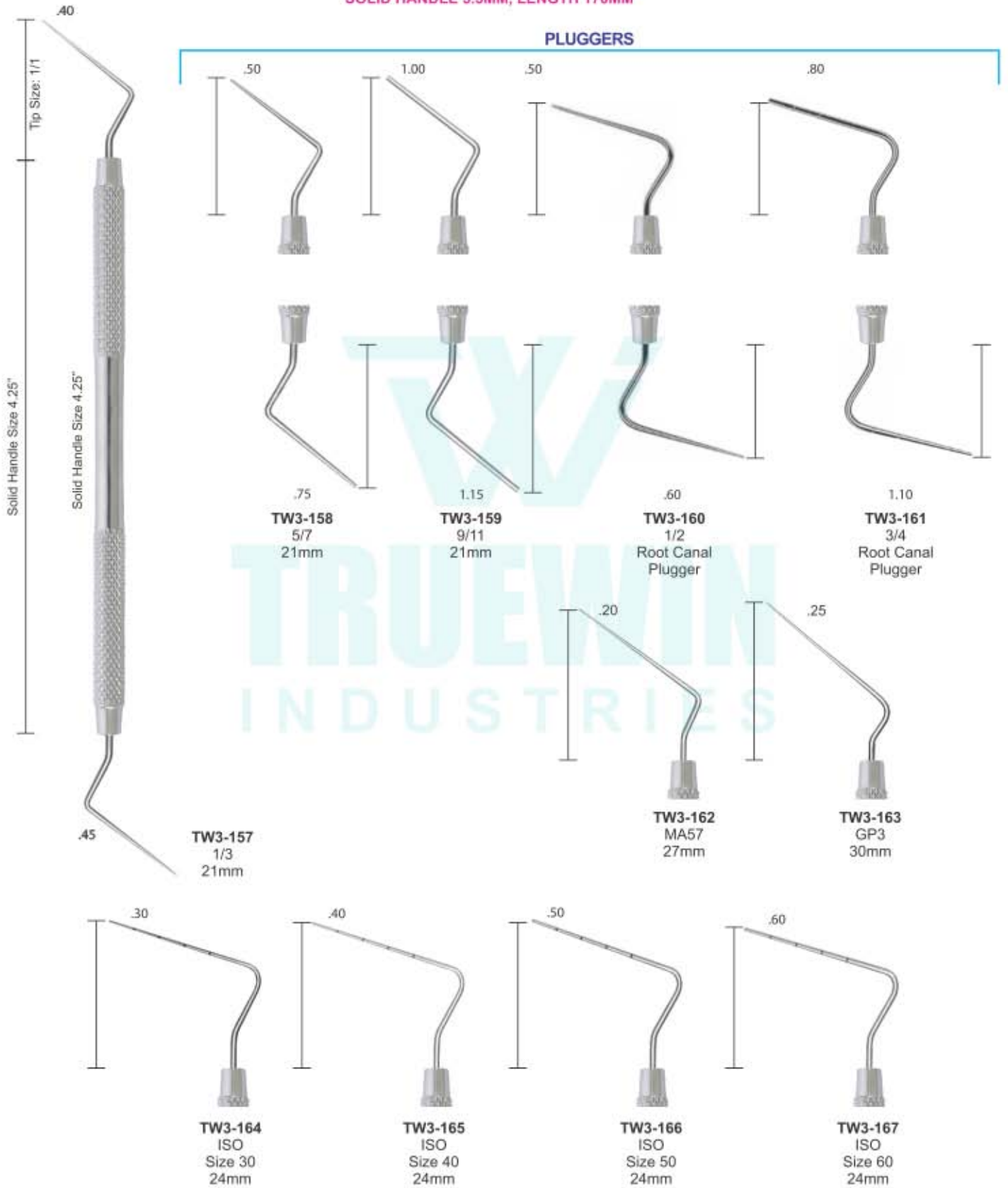

- Зонды пародонтологические
- зонди пародонтологічні
- Sondes paradontales
- Sondas paradontales
- sonda parodontali
- المسابر اللثة

Single Ended Solid Handle 5.5mm, Length 150mm

SPREADERS

Tip Size: 1/1

Solid Handle Size 4.25"

HEAT CARRIERS

HEAT CARRIERS

TW3-168
ISO
Size 30
24mm

TW3-169
ISO
Size 40
24mm

TW3-170
ISO
Size 50
28mm

TW3-171
ISO
Size 60
28mm

TW3-172
GP1
20mm

TW3-173
1S
Wakai
22mm

TW3-174
2S
Wakai
22mm

TW3-175
D11
Standard
23mm

TW3-176
D11S
Thin
23mm

TW3-177
D11T
Thinner
22mm

TW3-178
D11TS
Thinnest
21mm

TW3-179
3
28mm

TW3-180
GP2
25mm

TW3-181
0±
25mm

TW3-182
00±
25mm

PERIODONTAL PROBES



- Зонды пародонтологические
- зонди пародонтологічні
- Sondes paradontales
- Sondas paradontales
- sonda parodontali
- المسابر اللثة

Endodontics Instruments Single Ended Solid Handle 5.5mm, Length 150mm

ANTERIOR



LUKS



- Зонды пародонтологические
- зонди пародонтологічні
- Sondes paradontales
- Sondas paradontales
- sonda parodontali
- المسابر اللثة

ENDODONTICS INSTRUMENTS SOLID HANDLE 5.5MM, LENGTH 150MM
POSTERIOR

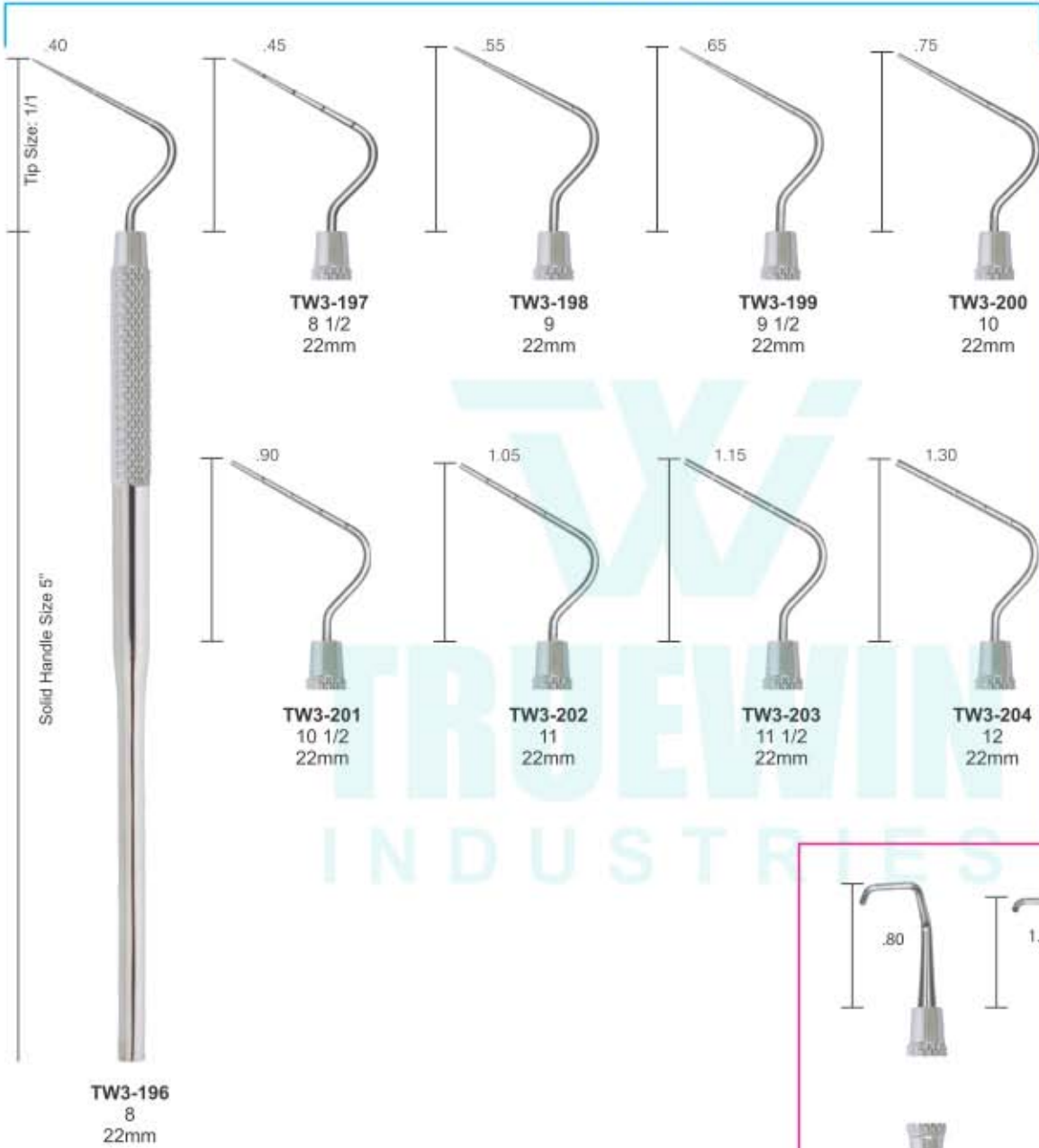

RETRO FILLING PLUGGERS

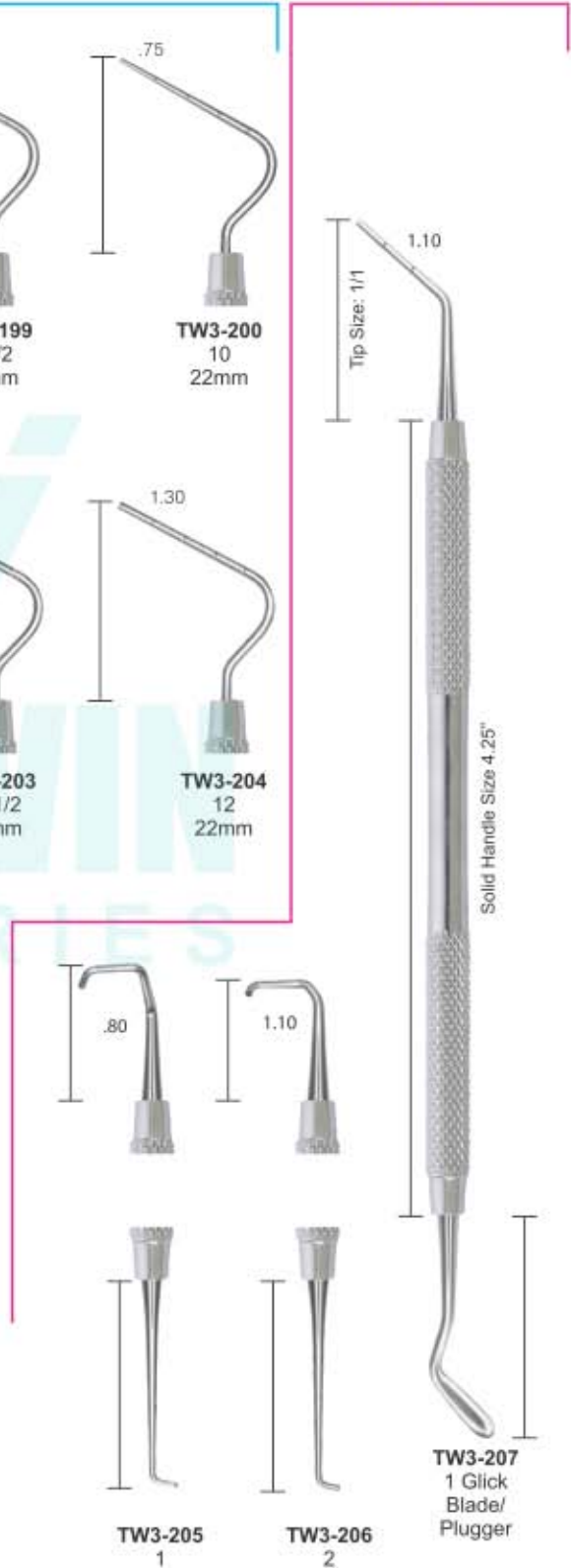

- Инструменты для реставрации
 - Instruments pour plombage
 - Füllungsinstrumente (mit Kontrawinkel)
- Instrumenti для реставрації
 - Instrumentos para obturaciones
 - ملء الصكوك

Amalgam and Plastic Filling Instruments



- Инструменты для реставрации
 - Instruments pour plombage
 - Füllungsinstrumente (mit Kontrawinkel)
- Инструменти для реставрації
 - Instrumentos para obturaciones
 - ملء الصكوك

Amalgam and Plastic Filling Instruments



- Инструменты для реставрации
 - Instruments pour plombage
 - Füllungsinstrumente (mit Kontrawinkel)
- Инструменти для реставрації
 - Instrumentos para obturaciones
 - ملء الصكوك

Amalgam and Plastic Filling Instruments



- Инструменты для реставрации
- Instruments pour plombage
- Füllungsinstrumente (mit Kontrawinkel)
- Инструменти для реставрації
- Instrumentos para obturaciones
- ملء الصكوك

Amalgam Instruments and Burnishers



- Инструменты для реставрации
 - Instruments pour plombage
 - Füllungsinstrumente (mit Kontrawinkel)
- Instrumenti для реставрації
 - Instrumentos para obturaciones
 - ملء الصكوك

Amalgam Instruments and Burnishers



- Инструменты для реставрации
 - Instruments pour plombage
 - Füllungsinstrumente (mit Kontrawinkel)
- Инструменти для реставрації
 - Instrumentos para obturaciones
 - ملء الصكوك

Plastic Filling Instruments



- Инструменты для реставрации
 - Instruments pour plombage
 - Füllungsinstrumente (mit Kontrawinkel)
- Инструменти для реставрації
 - Instrumentos para obturaciones
 - ملء الصكوك

Plastic Filling Instruments



- Инструменты для реставрации
- Instruments pour plombage
- Füllungsinstrumente (mit Kontrawinkel)
- Инструменти для реставрації
- Instrumentos para obturaciones
- ملء الصكوك

Composite Gold Coated Instruments



TW3-278
Markley 2



TW3-279
Westcott N.21



TW3-280
NYU/B2



TW3-281
Filling instruments



TW3-282
Ball Filling Instruments



TW3-283
Filling Instruments



TW3-284
Filling Instruments



TW3-285
Filling Instruments



TW3-286
Plastic Filling Instruments



TW3-287
Heidemann



TW3-288
Plastic Filling Instruments

- Инструменты для реставрации
- Instruments pour plombage
- Füllungsinstrumente (mit Kontrawinkel)
- Инструменти для реставрації
- Instrumentos para obturaciones
- ملء الصكوك

Composite Gold Tip Instruments

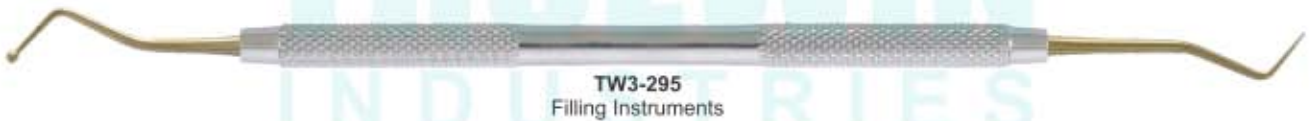
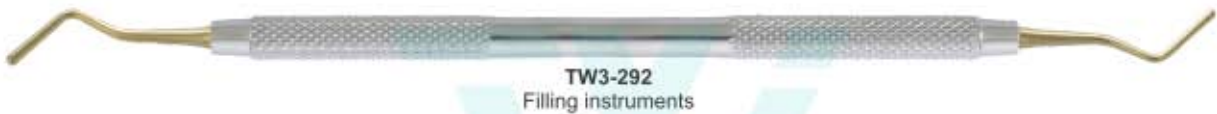

- Инструменты для реставрации
 - Instruments pour plombage
 - Füllungsinstrumente (mit Kontrawinkel)
- Инструменти для реставрації
 - Instrumentos para obturaciones
 - ملء الصكوك

CARVERS INSTRUMENTS

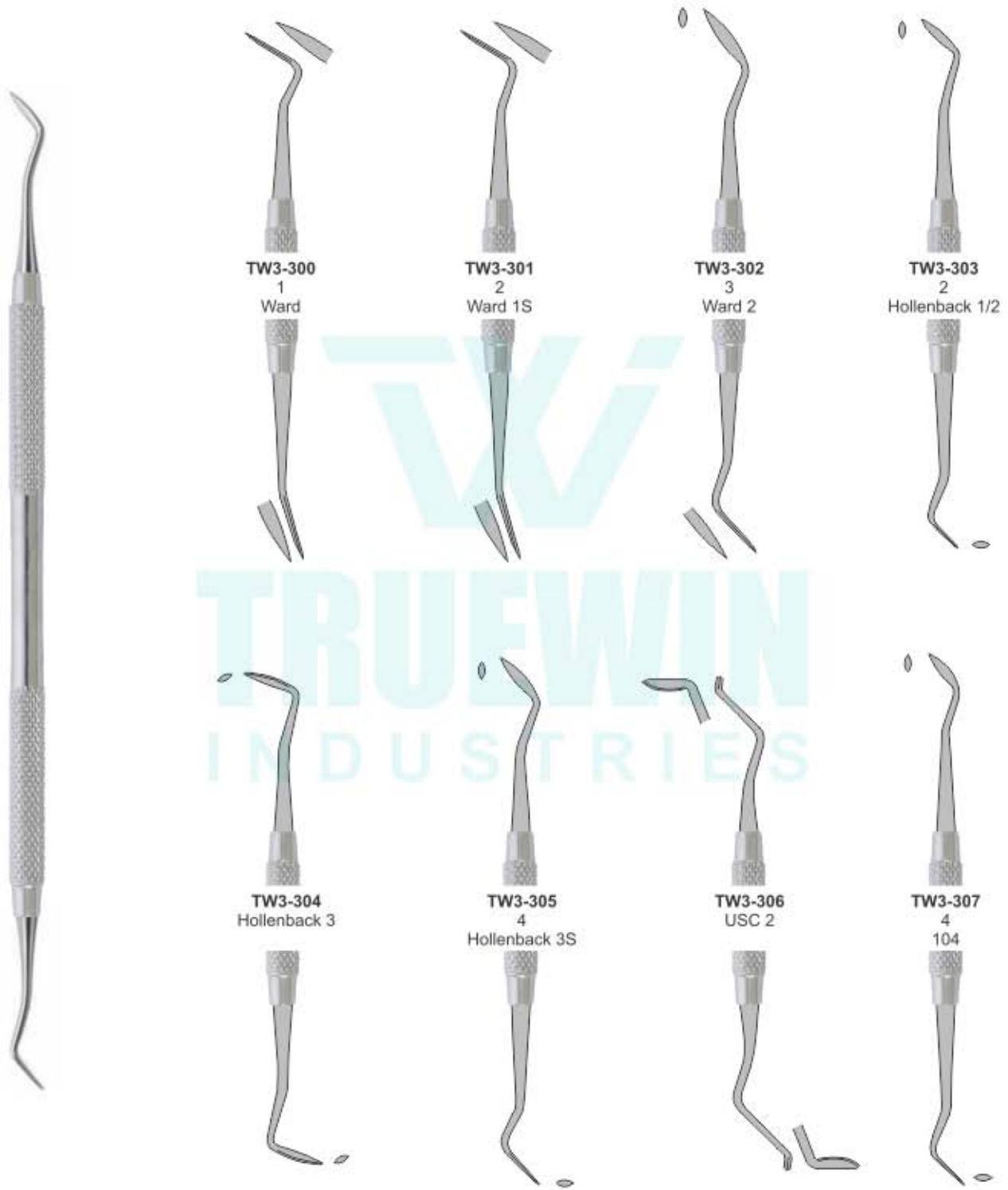

- Инструменты для реставрации
 - Instruments pour plombage
 - Füllungsinstrumente (mit Kontrawinkel)
- Інструменти для реставрації
 - Instrumentos para obturaciones
 - ملء الصكوك

CARVERS INSTRUMENTS



- Инструменты для реставрации
 - Instruments pour plombage
 - Füllungsinstrumente (mit Kontrawinkel)
- Инструменти для реставрації
 - Instrumentos para obturaciones
 - ملء الصكوك

CARVERS INSTRUMENTS

CLEOIDS



Nystrom

CHISELS



- Инструменты для реставрации
- Instruments pour plombage
- Füllungsinstrumente (mit Kontrawinkel)
- Инструменти для реставрації
- Instrumentos para obturaciones
- ملء الصكوك

ENAMEL INSTRUMENTS

MARGINTRIMMERS

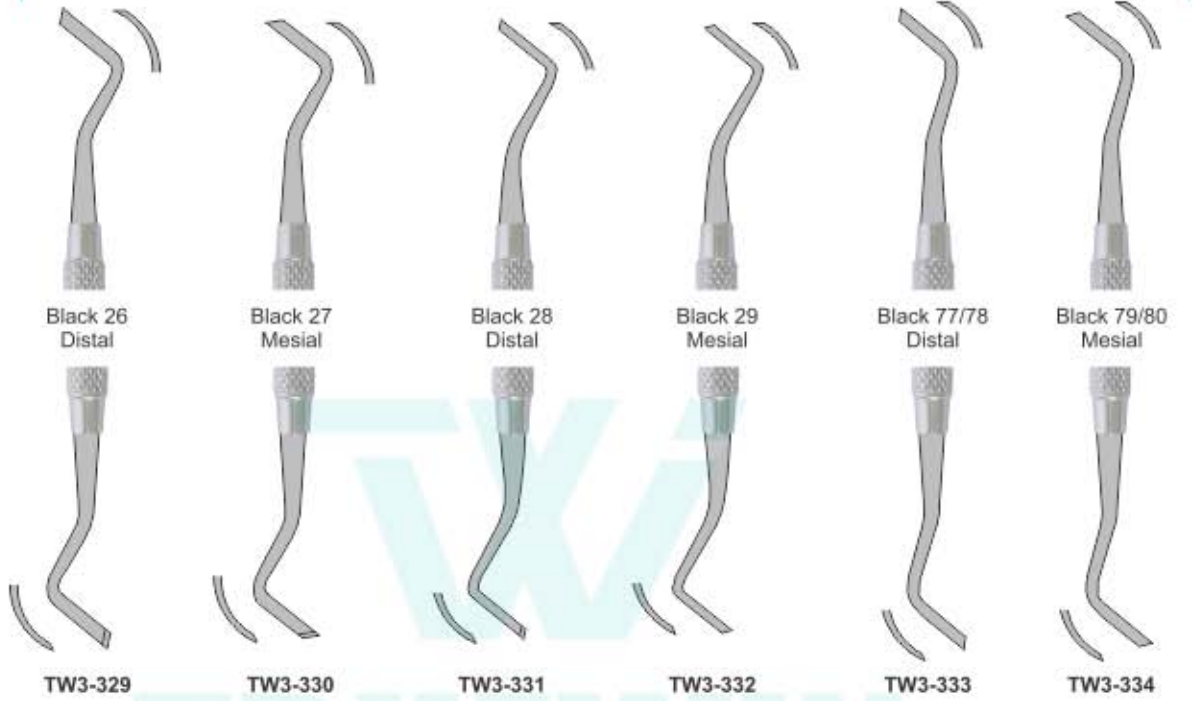

HATCHES



- Инструменты для реставрации
- Instruments pour plombage
- Füllungsinstrumente (mit Kontrawinkel)

- Инструменти для реставрації
- Instrumentos para obturaciones
- ملء الصكوك

CHISELS

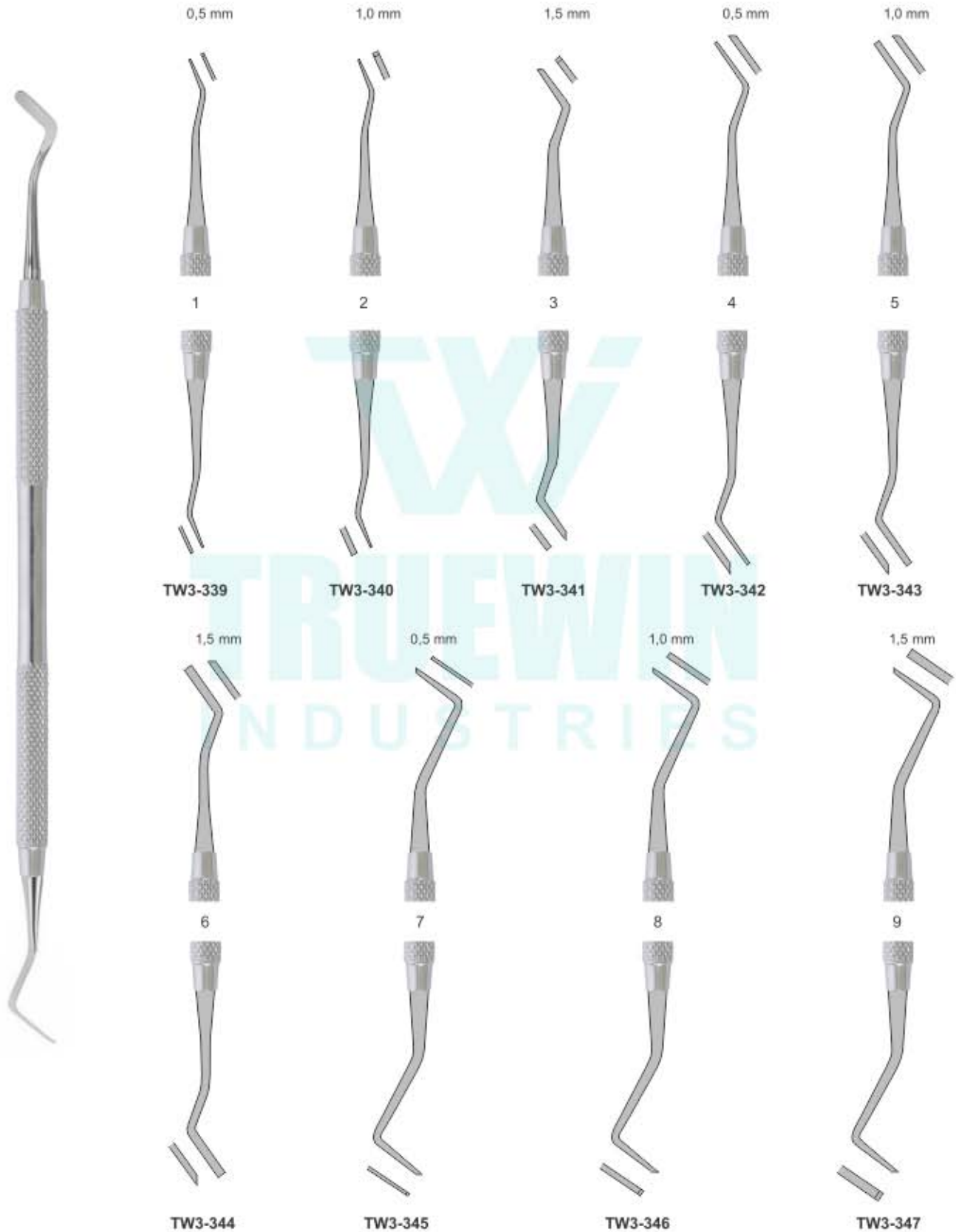

- Инструменты для реставрации
- Instruments pour plombage
- Füllungsinstrumente (mit Kontrawinkel)
- Инструменти для реставрації
- Instrumentos para obturaciones
- ملء الصكوك

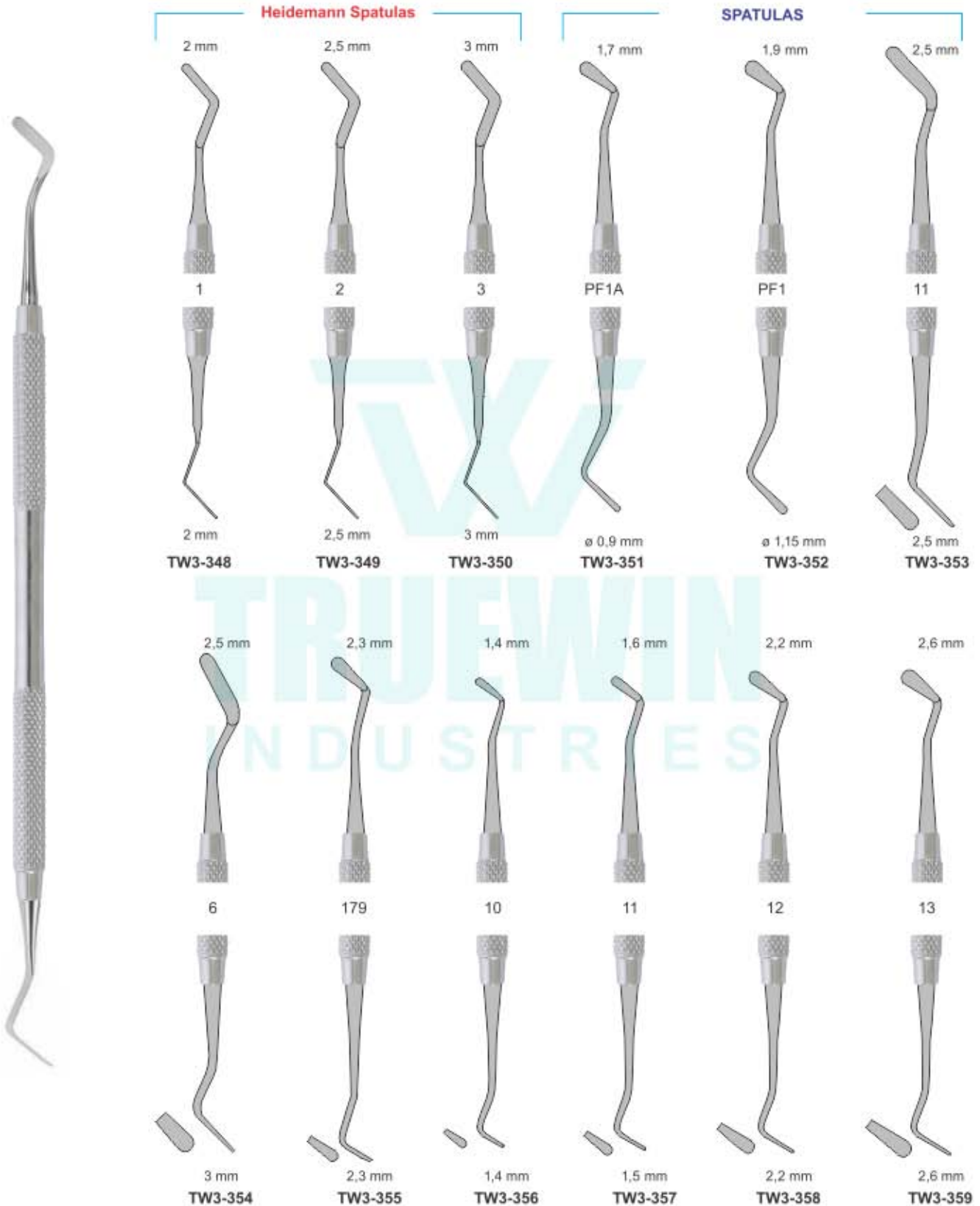

- Экскаваторы
 - Excavateurs
 - Excavatoren
- Excavatori
 - Excavadores
 - حطرات

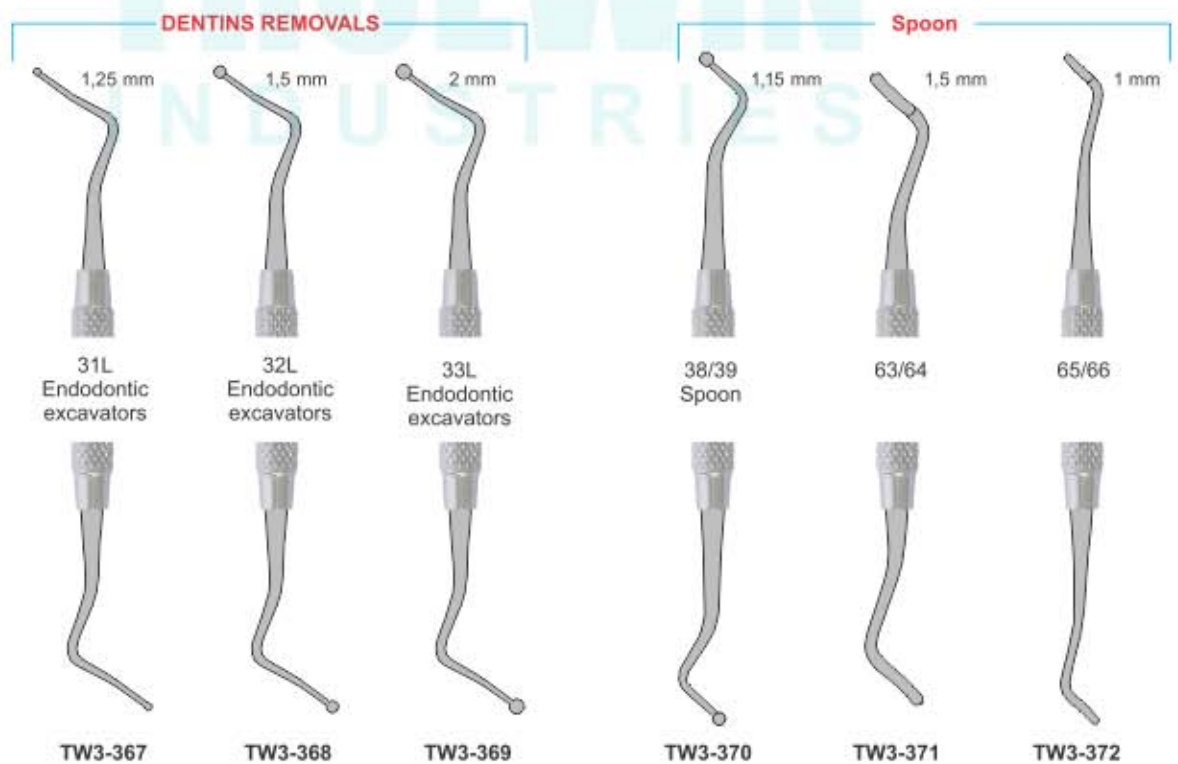
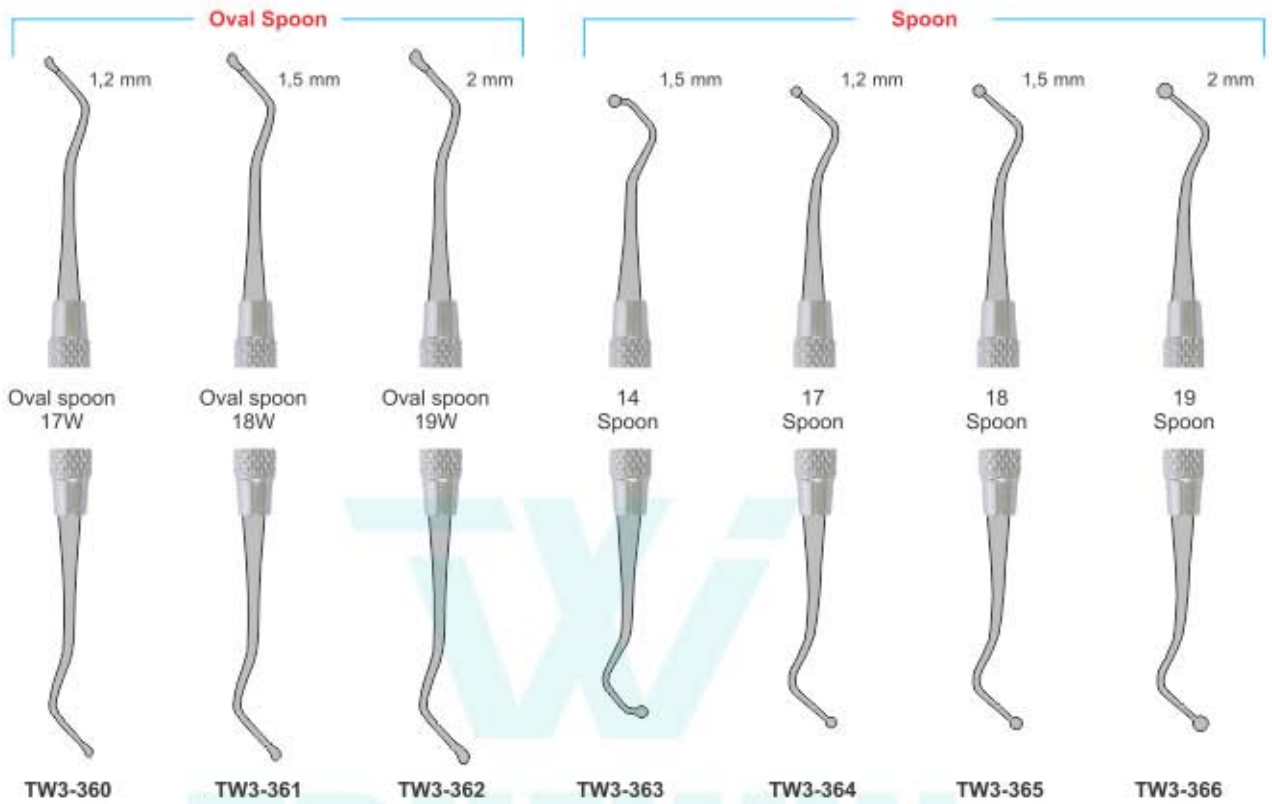

EXCAVATORS



- Экскаваторы
 - Excavateurs
 - Excavatoren
- Excavatori
 - Excavadores
 - حفارات



- Эскаваторы
 - Excavateurs
 - Excavatoren
- Эскаватори
 - Excavadores
 - حطرات

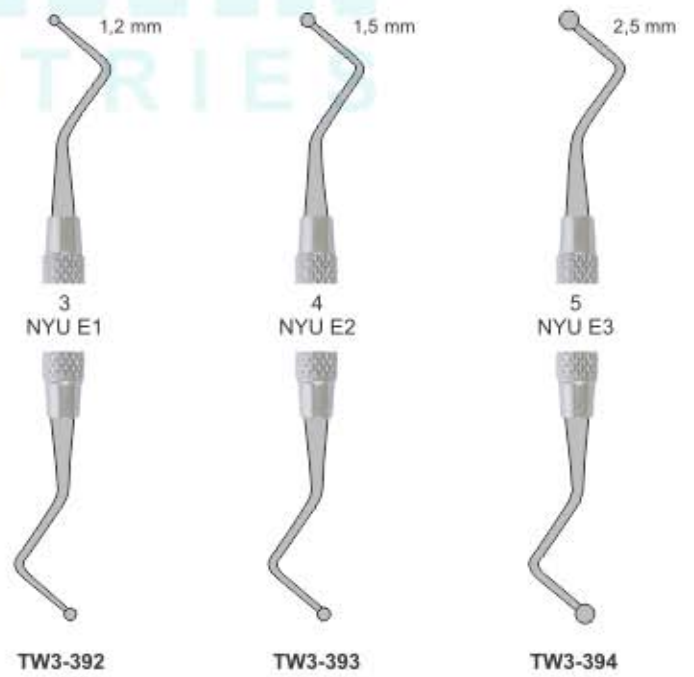

- Зонды
- Sondes
- Zahnsonden
- Зонди
- Sondas
- المستكشفين

PROBES

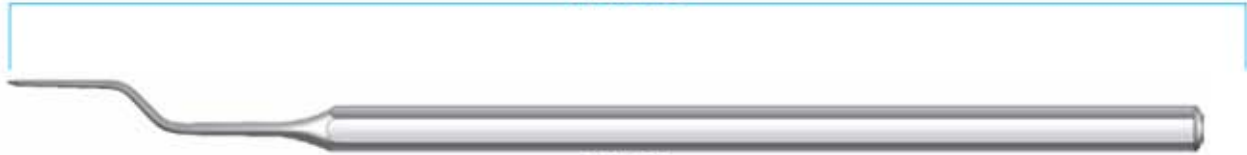

TW3-395
Probe

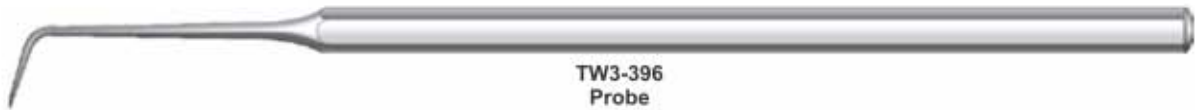

TW3-396
Probe



TW3-397
Probe

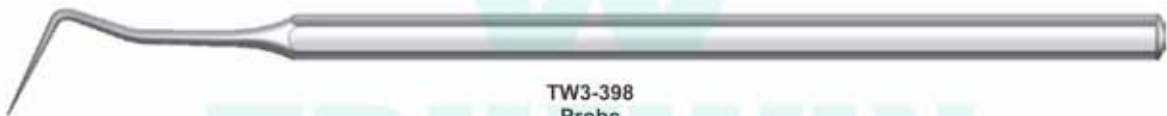

TW3-398
Probe

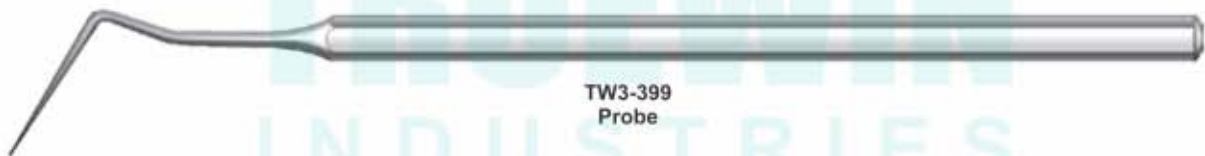

TW3-399
Probe



TW3-400
Probe



TW3-401
Probe



TW3-402
Probe

- Инструменты пародонтологические
 - Instruments pour la parodontologie
 - Instrumente für die Parodontologie
- Инструменти пародонтологічні
 - instrumentos para periodoncia
 - الصكوك اللثة



- Инструменты пародонтологические
- Instruments pour la parodontologie
- Instrumente für die Parodontologie
- Инструменти пародонтологічні
- instrumentos para periodoncia
- الصكوك اللثة

MODELLING INSTRUMENTS

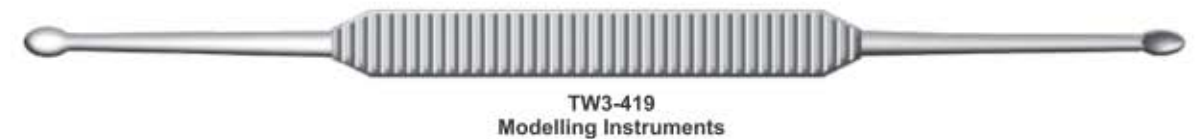
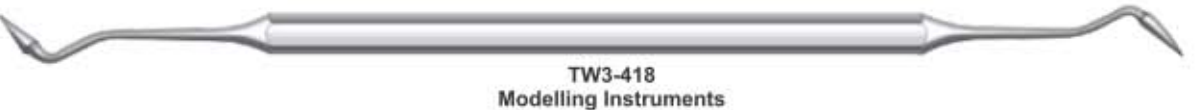
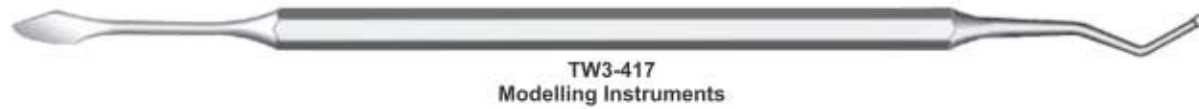
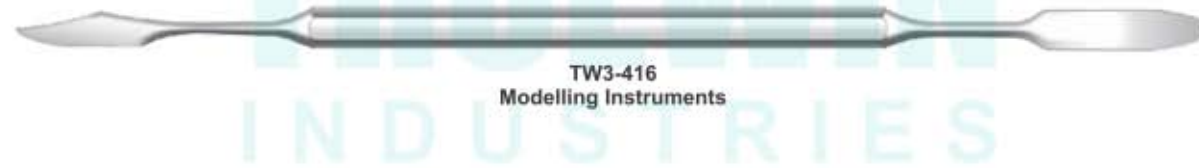
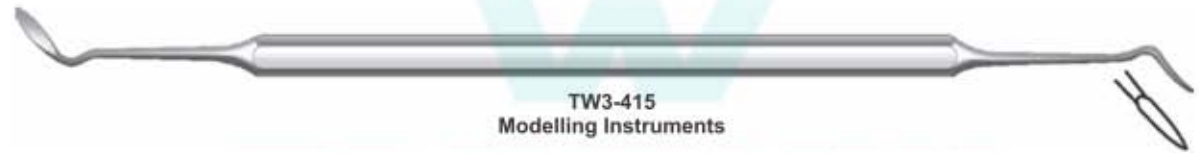
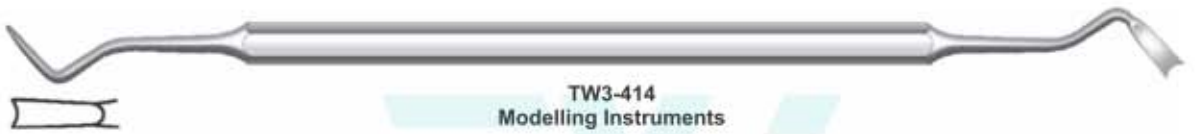
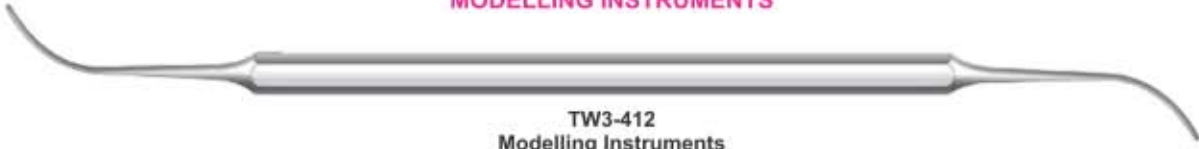

- Инструменты пародонтологические
- Instruments pour la parodontologie
- Instrumente für die Parodontologie
- Инструменти пародонтологічні
- instrumentos para periodoncia
- الصغوك اللثة

Periodontal Instruments Set



Cotton Meriam Tweezer

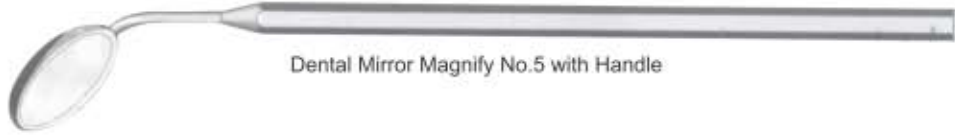

Dental Mirror Magnify No.5 with Handle

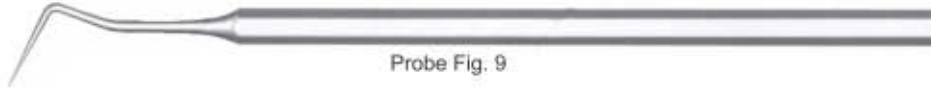

Probe Fig. 9



Excavator Tip Size Ø2mm-1,5mm



Excavator Tip Size Ø1,2mm-1,5mm



Plugger Tip Size Ø1,5mm-2mm

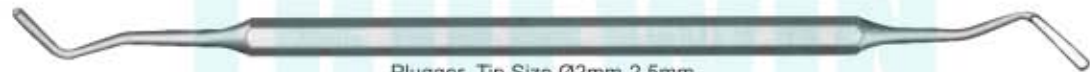

Plugger Tip Size Ø2mm-2,5mm



Ironing Crescent Tip Size Ø3mm-3,2mm



Ironing Crescent Tip Size Ø2,5mm-2,5mm



Cement Spatula Tip Size 6mm



TW3-420
Set of 10 Pieces.

- Инструменты пародонтологические
 - Instruments pour la parodontologie
 - Instrumente für die Parodontologie
- Инструменти пародонтологічні
 - instrumentos para periodoncia
 - الصكوك اللثة

PERIODONTAL FILES

Sugarman File Set

Excellent to remove and to crush strong calculus deposits

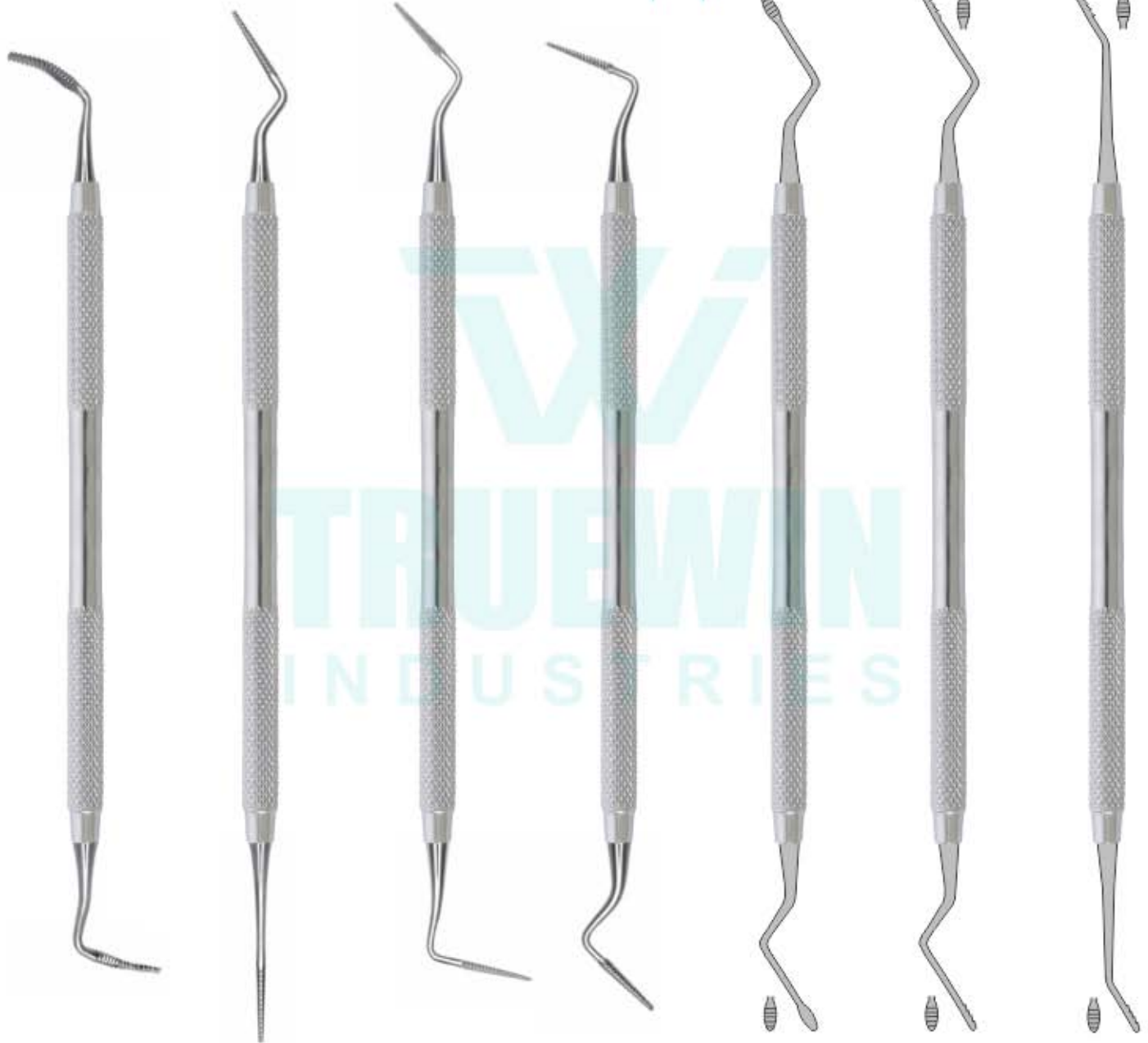

TW3-421
9/10
Schluger
Curved File

TW3-422
11/12
Buck
Straight File

TW3-423
1S/2S
Sugarman File

TW3-424
3S/4S
Sugarman File

TW3-425
3-7
Hirschfeld

TW3-426
5-11
Hirschfeld

TW3-427
9-10
Hirschfeld

- Инструменты пародонтологические
 - Instruments pour la parodontologie
 - Instrumente für die Parodontologie
- Инструменти пародонтологічні
 - instrumentos para periodoncia
 - الصكوك اللثة

PERIODONTAL FILES HOLLOW HANDLE 9.5MM, LENGTH 170MM

Sugarman File Set

Excellent to remove and to crush strong calculus deposits

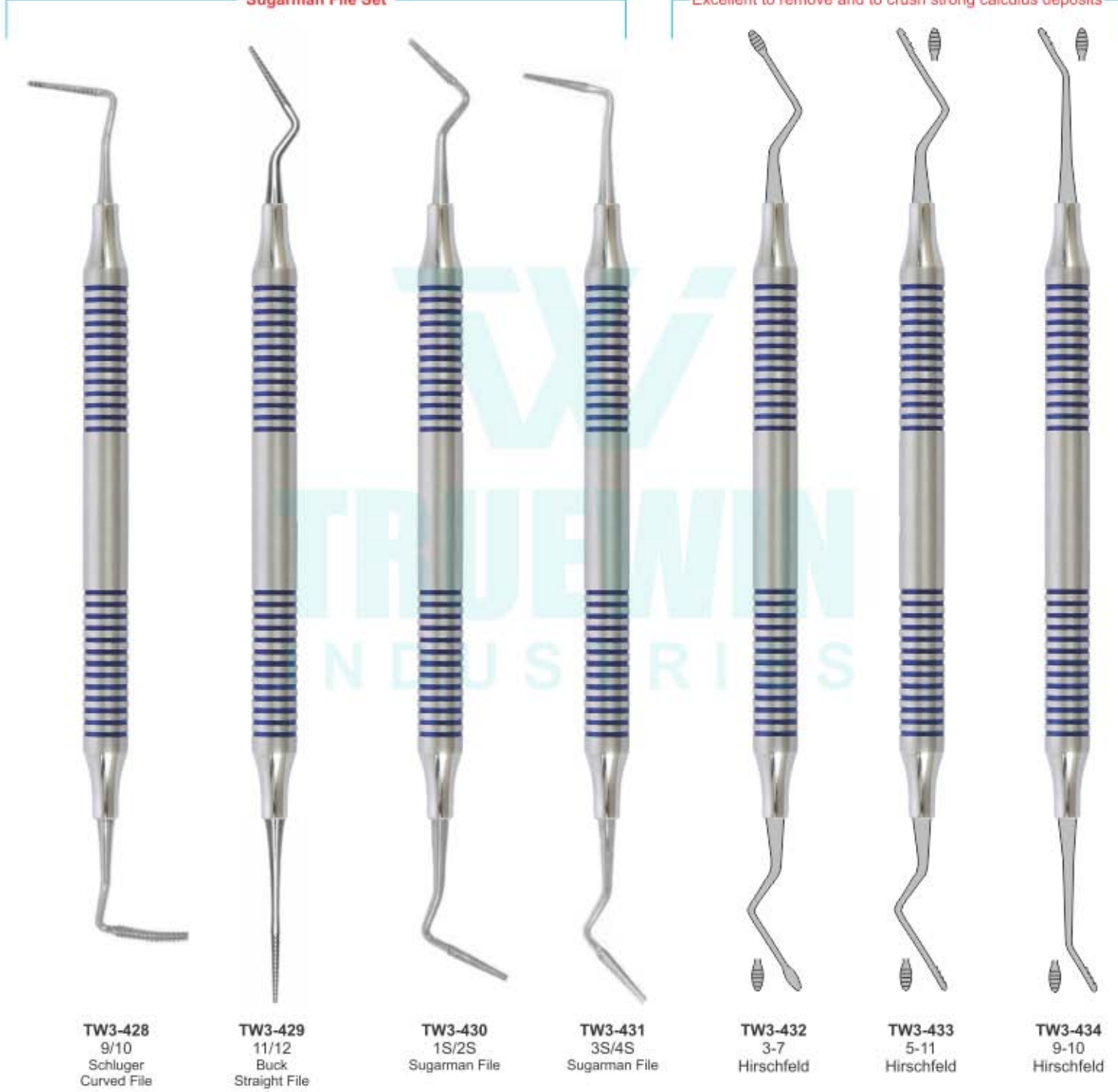

TW3-428
9/10
Schluger
Curved File

TW3-429
11/12
Buck
Straight File

TW3-430
1S/2S
Sugarman File

TW3-431
3S/4S
Sugarman File

TW3-432
3-7
Hirschfeld

TW3-433
5-11
Hirschfeld

TW3-434
9-10
Hirschfeld

CURETTES



- Кюрети
- Curetas
- Kuretten
- Кюрети
- Curette
- كرتس

Gracey Curesettes Solid Handle 5.5mm, Length 170mm



TW3-435
1/2

TW3-436
3/4

TW3-437
5/6

TW3-438
7/8

TW3-439
9/10

TW3-440
11/12

TW3-441
13/14

TW3-442
15/16

TW3-443
17/18

- Кюрети
- Curetas
- Kuretten
- Кюрети
- Curette
- كرتيس

Gracey Curettes Hollow Handle 9.5mm, Length 170mm

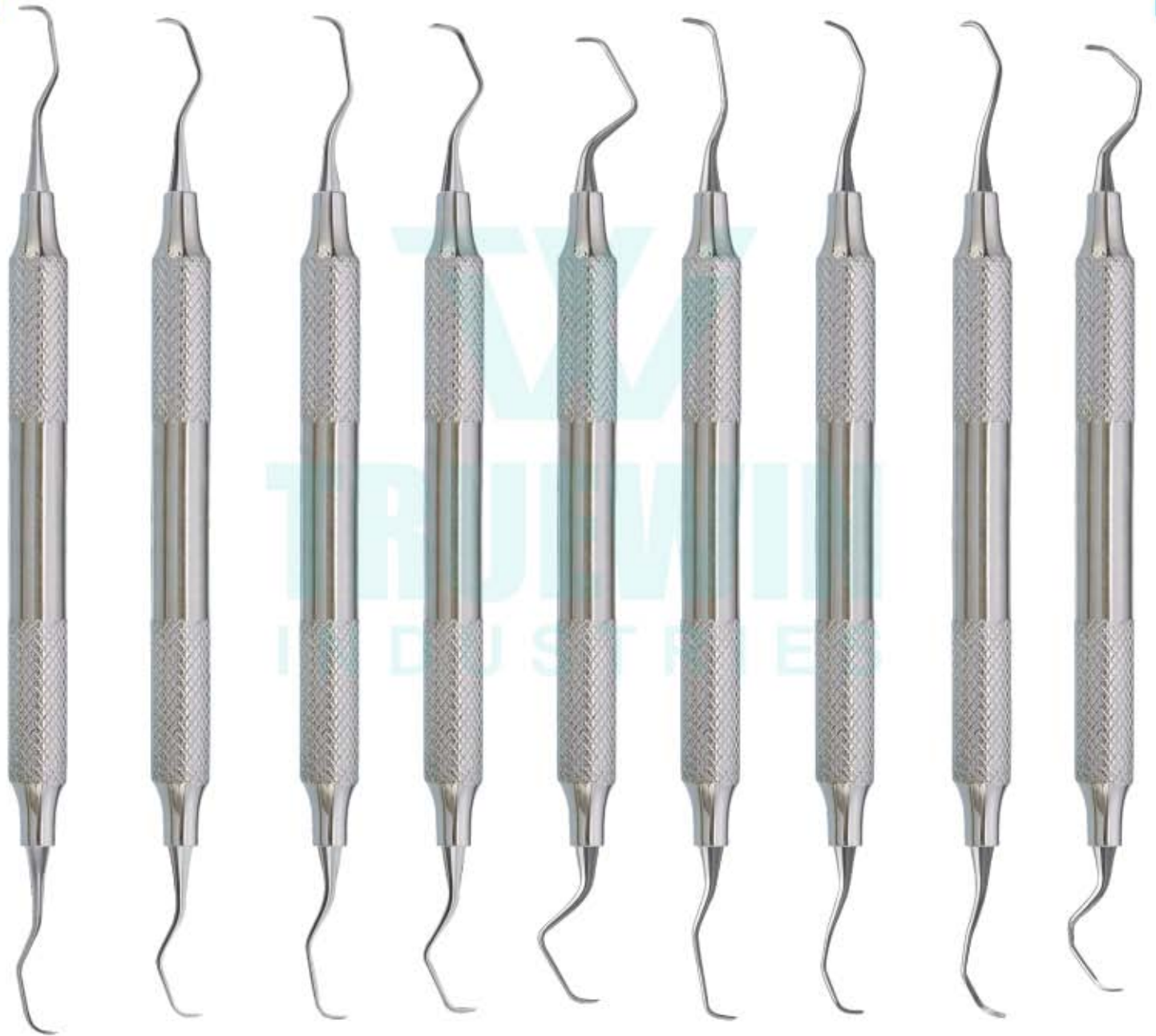

TW3-444
1/2

TW3-445
3/4

TW3-446
5/6

TW3-447
7/8

TW3-448
9/10

TW3-449
11/12

TW3-450
13/14

TW3-451
15/16

TW3-452
17/18

CURETTES



- Кюрети
- Curetas
- Kuretten
- Кюрети
- Curette
- كرتيس

TW3-453

GRACEY SET OF 7 PCS HOLLOW HANDLE PLASMA BLUE COATED 9.5MM, LENGTH 170MM



TW3-454
GRACEY
1/2



TW3-455
GRACEY
3/4



TW3-456
GRACEY
5/6



TW3-457
GRACEY
7/8



TW3-458
GRACEY
9/10



TW3-459
GRACEY
11/12



TW3-460
GRACEY
13/14

- Кюрети
- Curetas
- Kuretten
- Кюрети
- Curette
- كرتيس

TW3-461
GRACEY SET OF 7 PCS
HOLLOW HANDLE 9.5MM, LENGTH 170MM WITH SILICON GRIP



TW3-462
GRACEY
1/2

TW3-463
GRACEY
3/4

TW3-464
GRACEY
5/6

TW3-465
GRACEY
7/8

TW3-466
GRACEY
9/10

TW3-467
GRACEY
11/12

TW3-468
GRACEY
13/14

CURETTES



- Кюрети
 - Curetas
 - Küretten
- Кюрети
 - Curette
 - كورتس

GRACEY MINI FIVE

HOLLOW HANDLE 9.5MM, LENGTH 170MM
CERAMIC COATED HANDLE

GRACEY AFTER FIVE

HOLLOW HANDLE 9.5MM, LENGTH 170MM
CERAMIC COATED HANDLE

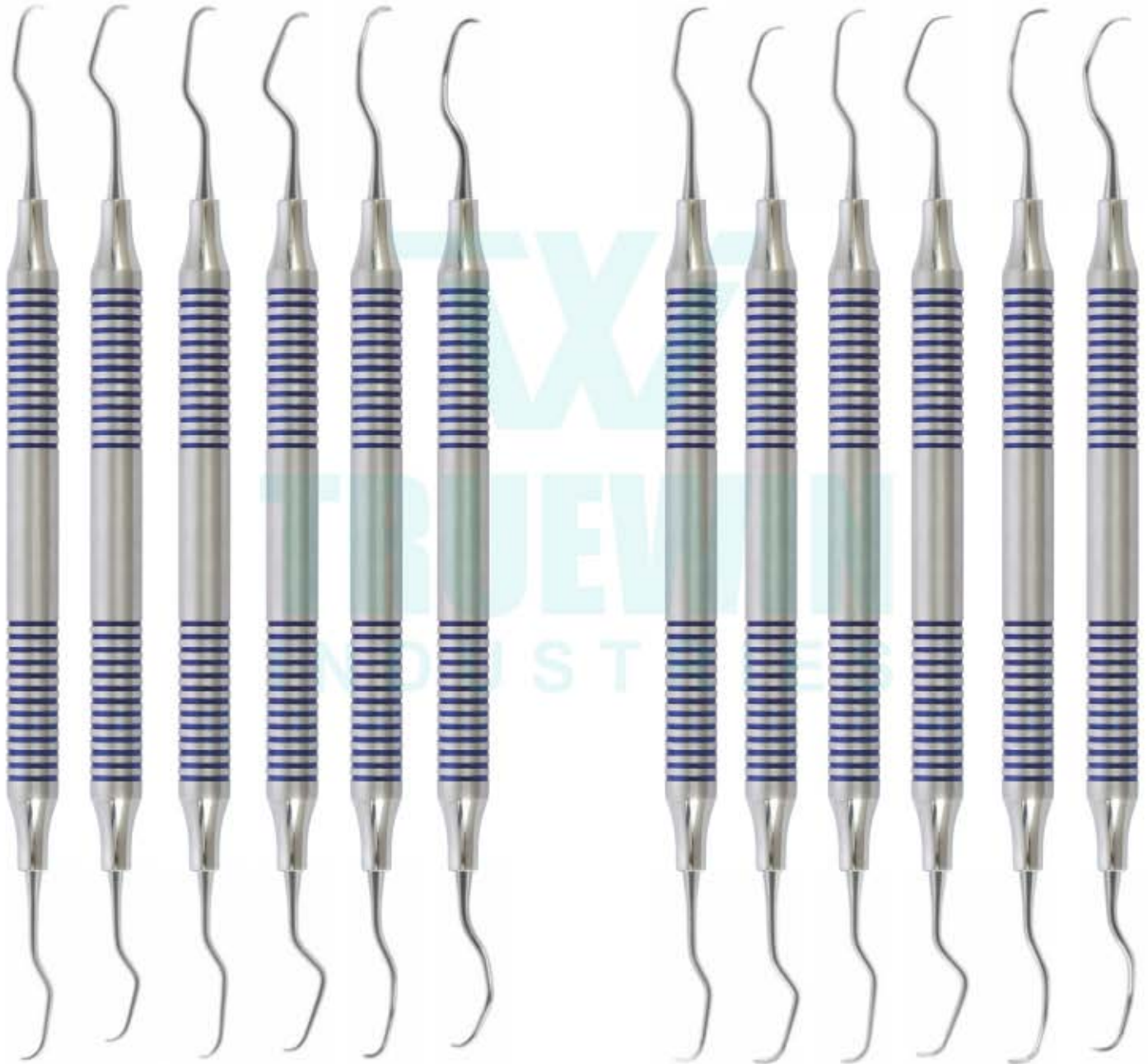

TW3-469 Gracey 1/2
 TW3-470 Gracey 3/4
 TW3-471 Gracey 5/6
 TW3-472 Gracey 7/8
 TW3-473 Gracey 11/12
 TW3-474 Gracey 13/14

TW3-475 Gracey 1/2 AF
 TW3-476 Gracey 3/4 AF
 TW3-477 Gracey 5/6 AF
 TW3-478 Gracey 7/8 AF
 TW3-479 Gracey 11/12 AF
 TW3-480 Gracey 13/14 AF

- Инструменты пародонтологические
 - Instruments pour la parodontologie
 - Instrumente für die Parodontologie
- Инструменти пародонтологічні
 - instrumentos para periodoncia
 - الصكوك اللثة

SICKLE SCALERS INSTRUMENTS SOLID HANDLE 5.5MM, LENGTH 170MM

SICKLE SCALERS



- Инструменты пародонтологические
 - Instruments pour la parodontologie
 - Instrumente für die Parodontologie
- Инструменти пародонтологічні
 - instrumentos para periodoncia
 - الصكوك اللثة

PERIODONTAL INSTRUMENTS SOLID HANDLE 5.5MM, LENGTH 170MM

JACQUETTE SCALERS

CRANE-KAPLAN



TW3-488
30/33
Hygienist
Jacquette

TW3-489
31/32
Jacquette

TW3-490
34/35
Jacquette

TW3-491
H3/H4
Jacquette

TW3-492
14/15
Posterior
Jacquette

TW3-493
CK-6

- Инструменты пародонтологические
- Инструменти пародонтологічні
- Instruments pour la parodontologie
- instrumentos para periodoncia
- Instrumente für die Parodontologie
- الصكوك اللثة

PERIODONTAL INSTRUMENTS SOLID HANDLE 5.5MM, LENGTH 170MM

SCALER CURETTE



- Инструменты пародонтологические
- Instruments pour la parodontologie
- Instrumente für die Parodontologie
- Инструменти пародонтологічні
- instrumentos para periodoncia
- الصكوك اللثة

SICKLE SCALERS INSTRUMENTS HOLLOW HANDLE 9.5MM, LENGTH 170MM

SICKLE SCALERS



TW3-501
H6/H7
Hygienist

TW3-502
6/7
Goldman

TW3-503
U15
Towner

TW3-504
H5/U15
Hygienist-
Towner

TW3-505
U15/30
Towner-
Jacquette

TW3-506
H15/33†
Hygienist-
Jacquette

TW3-507
U15/33
Towner-
Jacquette

- Инструменты пародонтологические
 - Instruments pour la parodontologie
 - Instrumente für die Parodontologie
- Инструменти пародонтологічні
 - instrumentos para periodoncia
 - الصكوك اللثة

PERIODONTAL INSTRUMENTS HOLLOW HANDLE 9.5MM, LENGTH 170MM

JACQUETTE SCALERS

CRANE-KAPLAN



- Инструменты пародонтологические
 - Instruments pour la parodontologie
 - Instrumente für die Parodontologie
- Инструменти пародонтологічні
 - instrumentos para periodoncia
 - الصكوك اللثة

PERIODONTAL INSTRUMENTS HOLLOW HANDLE 9.5MM, LENGTH 170MM

SCALER CURETTE



- Стоматологический набор скейлеров
- Instruments a detartrer
- Zahnreiniger
- Стоматологічний набір скейлерів
- Limpiadores de sarro
- المسطرون

SCALERS



- Стоматологический набор скейлеров
- Instruments a detartre
- Zahnreiner
- Стоматологічний набір скейлерів
- Limpiadores de sarro
- المسطرون

Tartar Remover Instruments



- Инструменты пародонтологические
 - Instruments pour la parodontologie
 - Instrumente für die Parodontologie
- Инструменти пародонтологічні
 - instrumentos para periodoncia
 - الصغوك اللثة

PERIODONTAL KNIVES SOLID HANDLE 5.5MM, LENGTH 170MM

PERIODONTAL KNIVES



TW3-536
1
Reddy Thin

TW3-537
2
Reddy Thin

TW3-538
3/4
Buck

TW3-539
5/6
Buck

TW3-540
1/2
Solt

TW3-541
1/2
Sanders

TW3-542
USC Towner
19/20

TW3-543
CK-3
Crane Kaplan

TW3-544
Dr. Allen
End-Cutting
Intrasulcular Knife

- Инструменты пародонтологические
 - Instruments pour la parodontologie
 - Instrumente für die Parodontologie
- Инструменти пародонтологічні
 - instrumentos para periodoncia
 - الصغوك اللثة

PERIODONTAL KNIVES SOLID HANDLE 5.5MM, LENGTH 170MM

PERIODONTAL KNIVES



TW3-545
15K/16K
Kirkland

TW3-546
1/2
Orban

TW3-547
1/2 Orban
Knife

TW3-548
7
Goldman-Fox

TW3-549
8
Goldman-Fox

TW3-550
9
Goldman-Fox

TW3-551
11
Goldman-Fox

- Инструменты пародонтологические
- Instruments pour la parodontologie
- Instrumente für die Parodontologie
- Инструменти пародонтологічні
- instrumentos para periodoncia
- الصغوك اللثة

PERIODONTAL CHISELS
Solid Handle 5.5mm, Length 170mm



- Инструменты пародонтологические
 - Instruments pour la parodontologie
 - Instrumente für die Parodontologie
- Инструменти пародонтологічні
 - instrumentos para periodoncia
 - الصكوك اللثة

PERIODONTAL CHISELS

Solid Handle 5.5mm, Length 170mm



TW3-560
1/2
Kramer-Nevins

TW3-561
36/37
Rhodes
Back-Action

TW3-562
44/45
Remington
Hoe

TW3-563
TG

TW3-564
TG-0
Modified TG with
Ochsenein cutouts

TW3-565
3/4
Solt

TW3-566
13K/TG

TW3-567
13K/13KL

- Кюрети
 - Curetas
 - Küretten
- Кюрети
 - Curette
 - كرتيس

BONE CURETTES

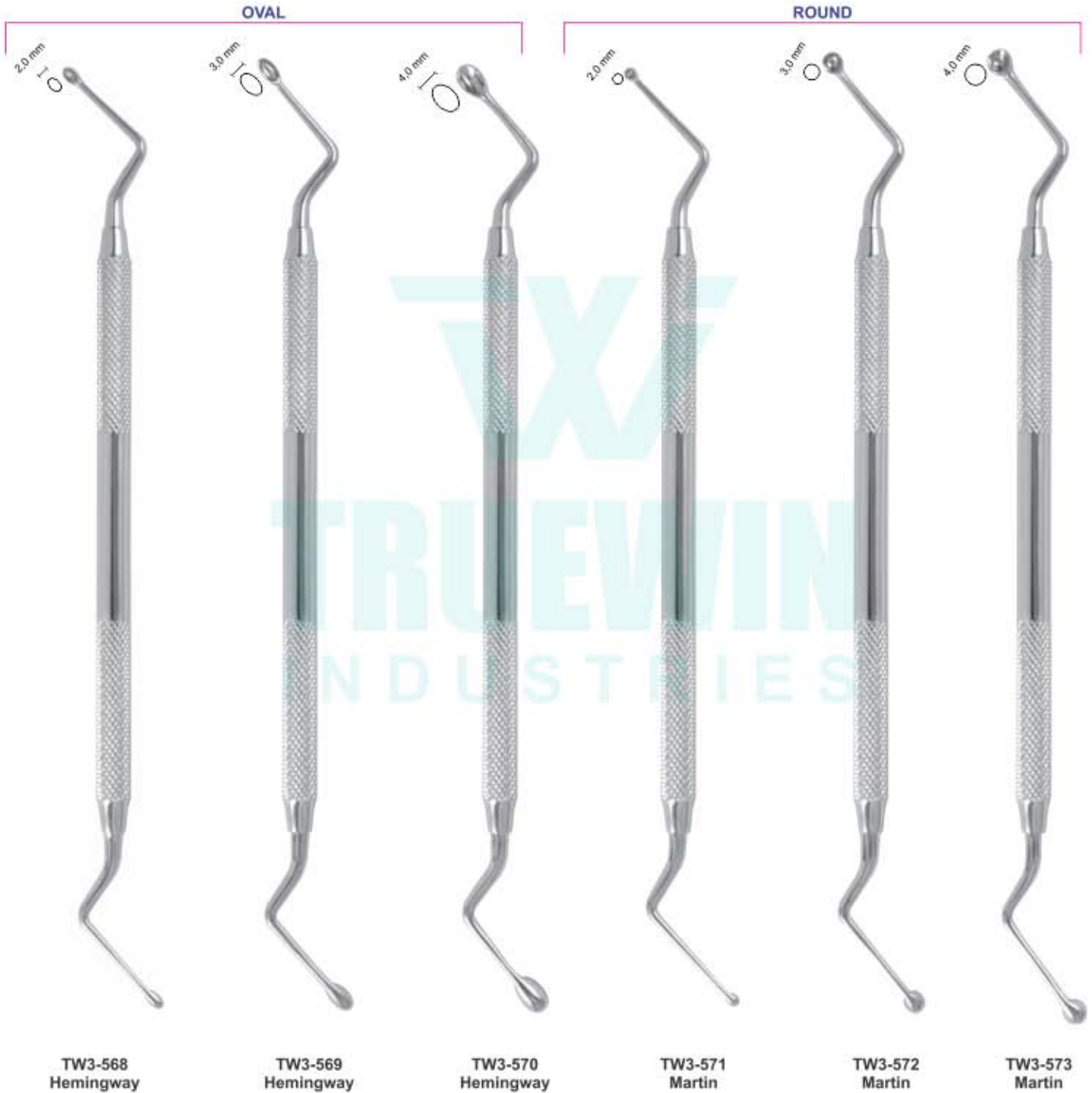

CURETTES



- Кюрети
 - Curetas
 - Küretten
- Кюрети
 - Curette
 - كورتس

SURGICAL CURETTES

Solid Handle 5.5mm, Length 170mm
LUCAS SPOON SHAPE

LUKAS



TW3-574
84

TW3-575
85

TW3-576
86

TW3-577
87

TW3-578
88

TW3-579
85/86
Lucas
Surgical Curette

TW3-580
86/87
Lucas
Surgical Curette

TW3-581
Lukas

TW3-582
Lukas

- Инструменты для реставрации
- Instruments pour plombage
- Füllungsinstrumente (mit Kontrawinkel)
- Инструменти для реставрації
- Instrumentos para obturaciones
- ملء الصكوك

P.K. THOMAS WAXING INSTRUMENTS

P.K. THOMAS WAXING INSTRUMENTS

Aluminium Handle
P.K. Thomas code color light handle 8mm
P.K. THOMAS WAXING INSTRUMENTS



TW3-583
PKT-1

TW3-584
PKT-2

TW3-585
PKT-3

TW3-586
PKT-4

TW3-587
PKT-5

TW3-588
PKT-1

TW3-589
PKT-2

TW3-590
PKT-3

TW3-591
PKT-4

TW3-592
PKT-5

- Инструменты для реставрации
- Instruments pour plombage
- Füllungsinstrumente (mit Kontrawinkel)
- Инструменти для реставрації
- Instrumentos para obturaciones
- ملء الصكوك

COMPOSITE INSTRUMENTS TITANIUM BLUE ENDODONTIC

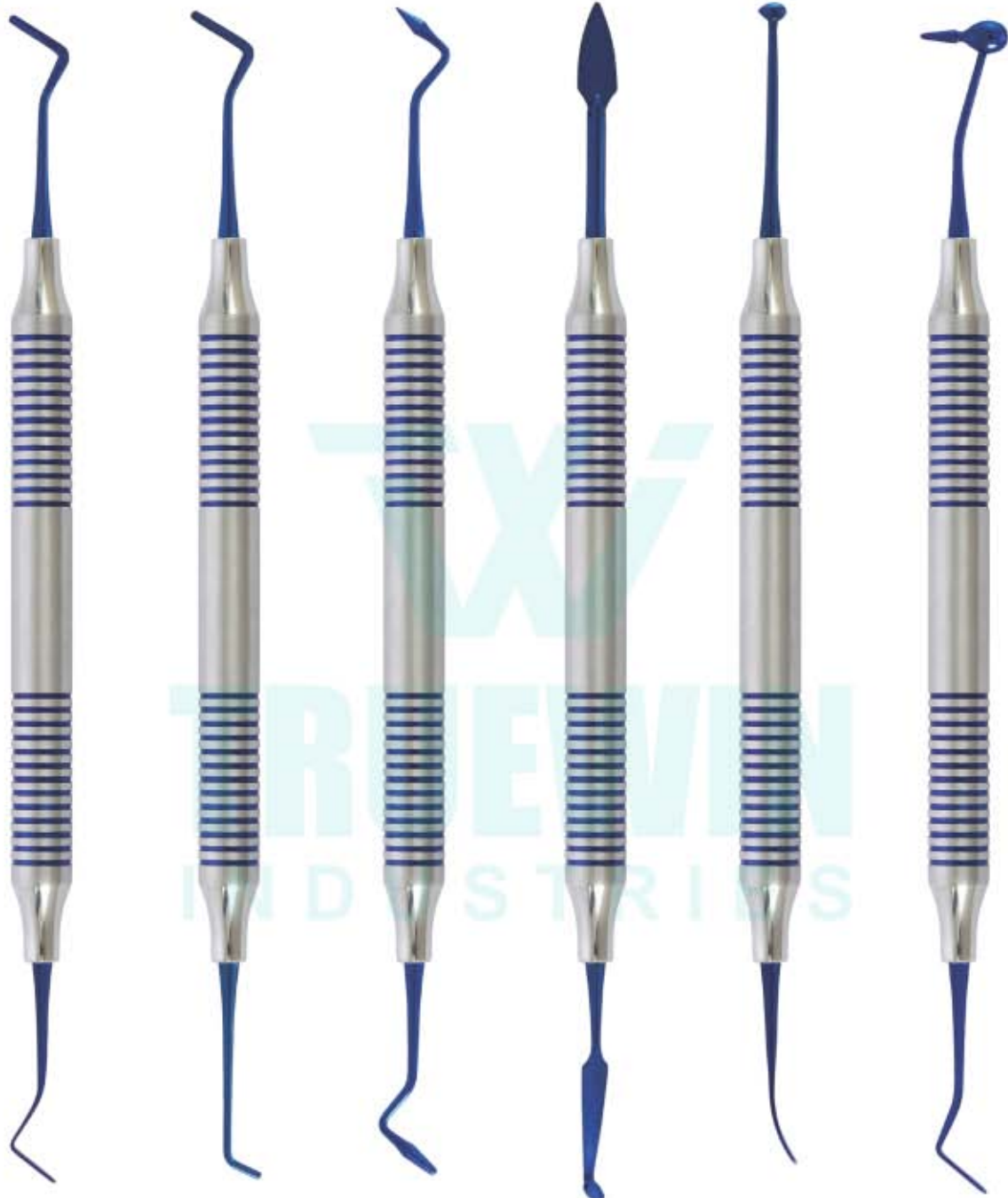

TW3-593

TW3-594

TW3-595

TW3-596

TW3-597

TW3-598



TW3-599
Composite Instruments Blue
Titanium with Cassettes

- Шпатели для цемента
 - Spatules à ciment
 - Zementspatel
- Шпатели для цементу
 - Espátulas para cemento
 - ملاعق الأسمنت



TW3-600
Fig. 1



TW3-601
Fig. 2



TW3-602
Fig. 3

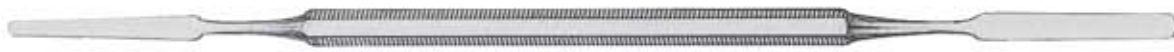

TW3-603
Fig. 00

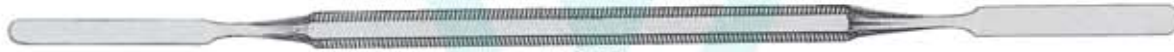

TW3-604
Fig. 0



TW3-605
Fig. 1



TW3-606
Fig. 2



TW3-607
Fig. 3



TW3-608
Fig. 4



TW3-609
Weston



TW3-610



TW3-611

- Инструменты для реставрации
- Instruments a modeler
- Modellierinstrumente
- Инструменти для реставрації
- Instrumentos para modelar
- أدوات تلميع

Wax and Modelling Carvers



TW3-612
Le Cron

TW3-613
Zahle

TW3-614
Zahle

TW3-615
Zahle

TW3-616
Gritman

TW3-617
Beale

TW3-618
Roach

TW3-619
Vehe

- Инструменты для реставрации
- Instruments a modeler
- Modellierinstrumente
- Инструменти для реставрації
- Instrumentos para modelar
- أدوات تظطیع



TW3-620

Graded Handle Hylin Carver



TW3-621
Hylin

TW3-622
Hylin-Le Cron

TW3-623
Hylin-Ceramica

TW3-624
Hylin

TW3-625

TW3-626
Le Cron

TW3-627
Le Cron

TW3-628
Le Cron

WAX KNIVES



- Ножи для воска
- Couteaux à cire
- Wachsmesser

- Ножи для воску
- Cuchillos para cera
- السكاكين الشمع

WAX KNIVES



TW3-629
Fig. 1
Fahnenstock
125mm

TW3-630
Fig. 2
Fahnenstock
170mm

TW3-631
Fig. 1
Lessmann
125mm

TW3-632
Fig. 2
Lessmann
170mm

TW3-633
Fig. 1
with small spoon
125mm

TW3-634
Fig. 2
with large spoon
170mm

- Ножи для воска
- Couteaux à cire
- Wachsmesser
- Ножи для воску
- Cuchillos para cera
- السكاكين الشمع

PLASTER KNIVES



TW3-635
160mm



TW3-636
160mm



TW3-637
Buffalo



TW3-638
Buffalo



TW3-639
Plaster Knife



TW3-640
170mm

- Ножи для воска
- Couteaux à cire
- Wachsmesser

- Ножи для воску
- Cuchillos para cera
- السكاكين الشمع

WAX KNIVES



TW3-641
Sachs



TW3-642
130mm
Ermert



TW3-643
Hook Knives



TW3-644
125mm
Antkoviak

TW3-645



TW3-646
Special Inox
200mm

- Шпатель для замешивания
- Spatules a alginate et a platre
- Alginat- und Gipsspatel
- Шпатель для змішування
- Espatulas para alginato y para yeso
- ملاعق الجبس الجينات

WAX SPATULAS



ARTICULATORS



- Артикуляторы
- Artocilar
- Artikulations

- Артикулятори
- Articulier
- ارتیکولاتورس



TW3-653
Articulator



TW3-654
Articulator



TW3-655
Articulator
S



TW3-658
Articulator



TW3-656
Articulator
M



TW3-657
Articulator
L

- Артикуляторы
- Artocilar
- Artikulations

- Артикулятори
- Articulere
- ارتیکولاتورس



TW3-659
Articulator



TW3-660
Articulator



TW3-661
Articulator



TW3-662
Articulator



TW3-663
Articulator



TW3-664
Articulator

- Артикуляторы
- Artocilar
- Artikulations

- Артикулятори
- Articulere
- ارتیکولاتورس

TW3-665

Technical Datas:

Intercondylar distance	120 mm.
condylar inclination	fixed at 30°
Bennet angle	fixed at 7°
Incisal table inclination	10°
Distance between mounting plates	110 mm.
Weight	700 gr.
Opening	180°

features:

Lightweight anatomic articulator made of aluminum die-casting, it can be used following the geometrical laws of medium values (Bonwill triangle). Fixing according to centric. Automatic return to the hinge axis with springs. Perfect stability also in reversed position. Easy access and visibility to the lingual surfaces. Interchangeable self centring aluminum mounting plates.



TW3-667
Anvil
Dental Laboratory
Instrument

Increased height and width

- (1) More space when using removable stumps systems.
- (2) More space for installation of mobile prosthesis with high chewing or big base.
- (3) More space when using magnetic plates

TW3-666

Technical Datas:

Intercondylar distance	120 mm.
condylar inclination	fixed at 30°
Bennet angle	fixed at 7°
Incisal table inclination	flat
Distance between mounting plates	110 mm.
Weight	700 gr.
Opening	180°

Special Features:

Adjustable back by registration screw to work without incisal rod by keeping constant trajectories and inclinations during side and back/forward movements. Pure translation movement (key and instructions included). Anti-shock hinge rod in case articulator falls down. Bigger size lock screws for mounting plates.



- Артикуляторы
- Artocilar
- Artikulations

- Артикулятори
- Articuler
- ارتیکولاتورس

TW3-668

Technical Datas:

Intercondylar distance	120 mm.
condylar inclination	fixed at 30°
Bennet angle	fixed at 7°
Incisal table inclination	10°
Distance between mounting plates	85 mm.
Weight	400 gr.
Opening (item 5000)	125°
Opening (item 5010)	180°



TRUEWIN

 INDUSTRIES

TW3-669

Technical Datas:

Intercondylar distance	110 mm.
condylar inclination	fixed at 30°
Bennet angle	fixed at 7°
Incisal table inclination	flat
Distance between mounting plates	85 mm.
Weight	450 gr.
Opening	180°



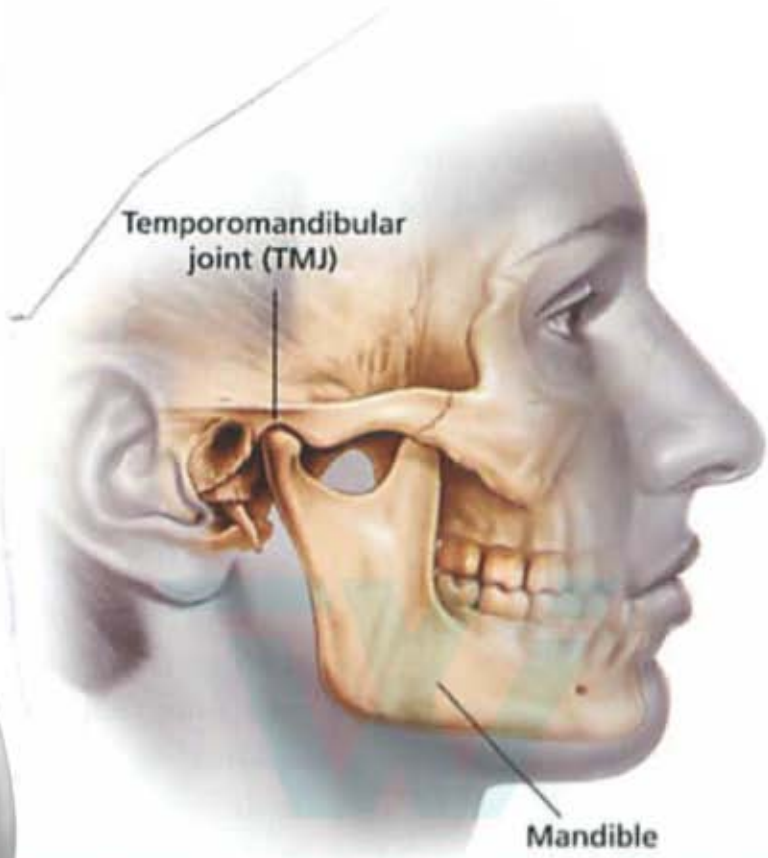

TRUEWIN
INDUSTRIES



Truewin Maxiofacial Surgery Instruments

A Bard-Parker handle with a No. 15 blade is the usual scalpel used to make incisions on the gums where a flap can be raised to gain access to tooth.

Retractors

Tongue, cheek and flap retractors are needed to provide adequate access to the tooth and are legion in number.

Needle Holders and Sutures

Sutures are used to replace and secure the gum flap in its former position, to limit the size of the wound and therefore restrict subsequent contamination with food debris, and to assist in controlling bleeding.

The usual suture size for intra-oral work is 4/0 and the material may be absorbable or non-absorbable Scissors

Dissecting scissors and suture-cutting scissors are usually used.

Artery Forceps

These are designed to hold soft tissue without damaging it.

College tweezers are used to lift up sutures prior to removing them.

Periosteal Elevators

A number are available and are similarly used like a normal elevator but periosteal elevators have two heads – one at each end.

One end is sharp-tipped to expand the tooth socket while the other has a blunt end to remove granulation tissues or raise a gum flap.

Chisels and Mallet

Chisels are more appropriate in the operating theatre and are particularly useful for disto-angular third molars and upper wisdom teeth extraction.

Bone Curettes

The Mitchells trimmer is probably the most valuable instrument in the category and is used to remove granulation tissue in the tooth socket.

Bone Ronguer and Bone File

Used to smoothen any sharp bone edges after tooth extraction is done.



- Ручки для скальпелей
 - Manches de bistouris
 - Skalpellgriffe
- Ручки для скальпелів
 - Mangos de bisturi
 - مشرط مقابض

Scalpel Handles

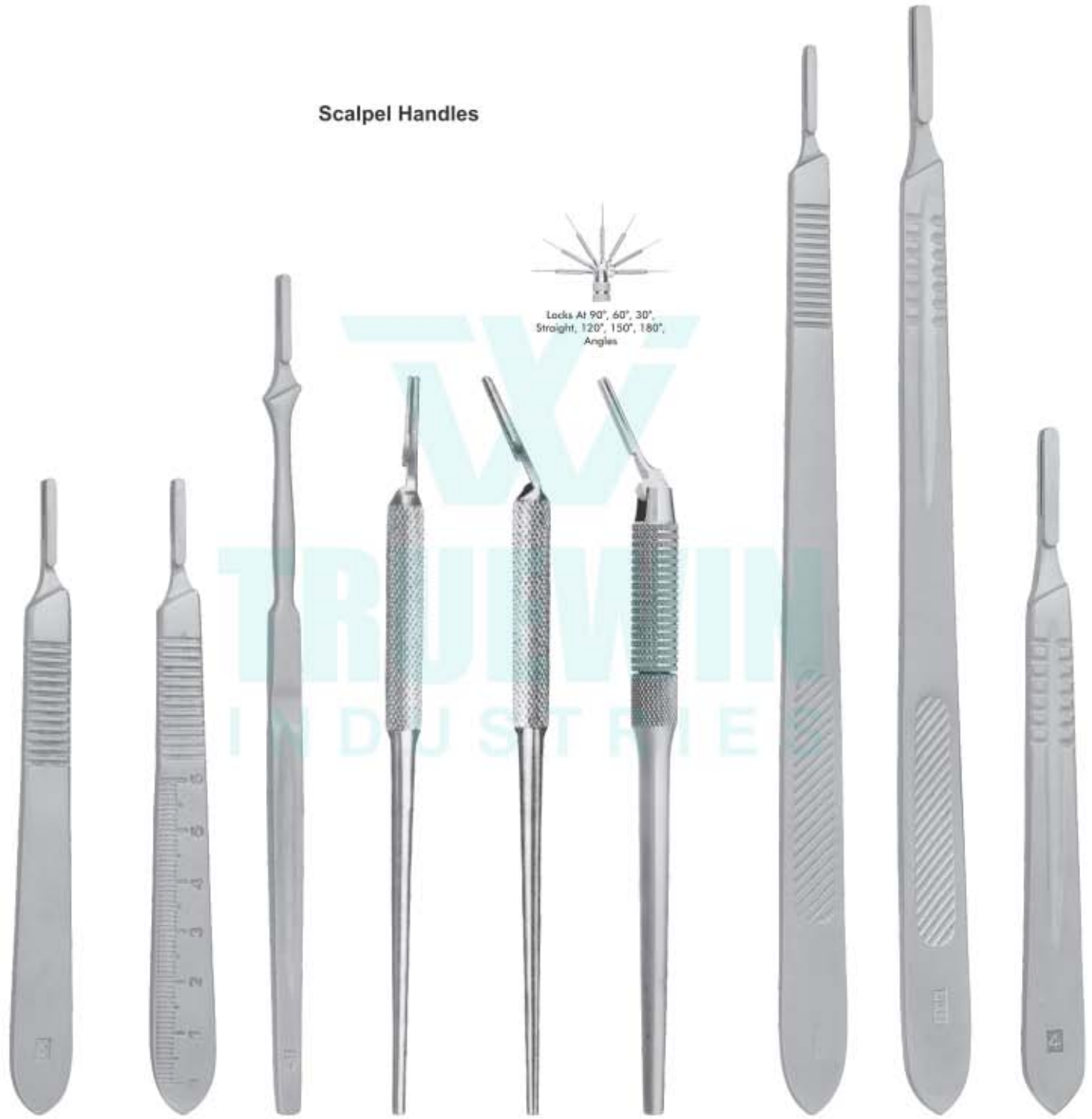

TW4-01
Fig. 3
125mm

TW4-02
Fig. 3
125mm

TW4-03
Fig. 7
165mm

TW4-04
Fig. 5
145mm

TW4-05
Fig. 5A
145mm

TW4-06
6 Way Adjustable
Angled
Scalpel Handle

TW4-07
Fig. 3L
210mm

TW4-08
Fig. 4L
218mm

TW4-09
Fig. 4
135mm

- Ножи для скальпеля и скальпеля
- Ножи скальпельного леза та скальпеля
- Scalpel Blade & Scalpel Knives
- Cuchillos de Escalpele y Escalpele
- Scalpel Blade & Scalpel Messer
- مشرط شفرة و مشرط المسككين

STERIL SCALPEL BLADES

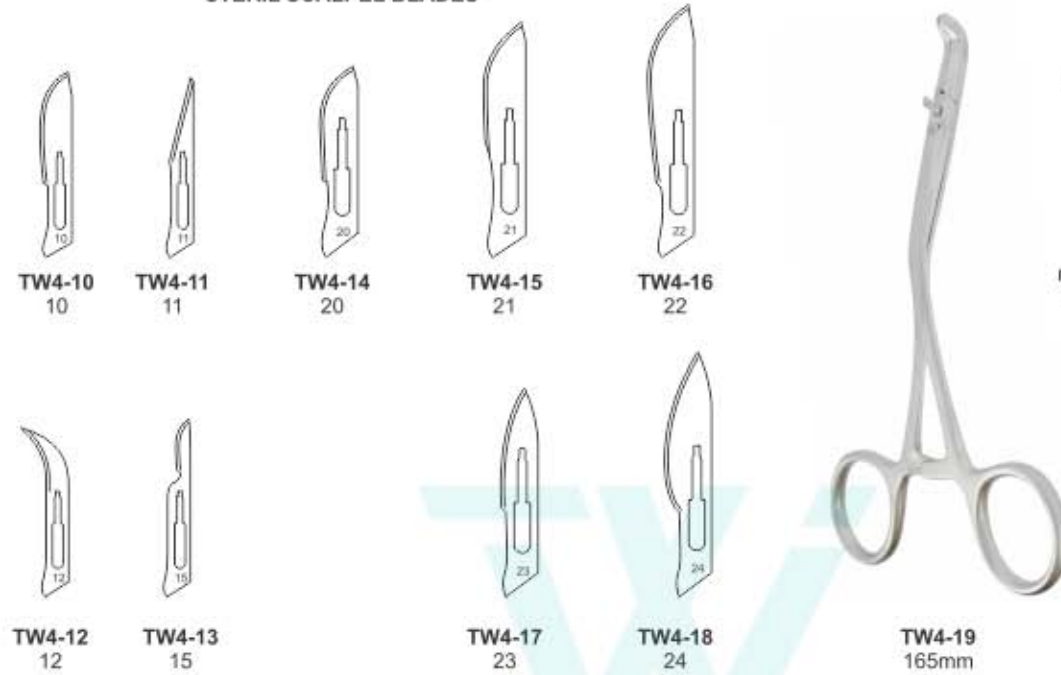

SCALPEL KNIVES



SCALPEL KNIVES



- Скальпельные ножи
 - Couteaux à scalpel
 - Skalpellmesser
- Ножи скальпеля
 - Cuchillos Scalpel
 - سكاكين مشرط



TW4-28
Fig. 1
160mm, 6 1/4"



TW4-29
Fig. 2
160mm, 6 1/4"



TW4-30
Fig. 3
160mm, 6 1/4"



TW4-31
Fig. 4
160mm, 6 1/4"



TW4-32
Fig. 5
160mm, 6 1/4"



TW4-33
Fig. 6
160mm, 6 1/4"



TW4-34
Fig. 7
160mm, 6 1/4"



TW4-35
Fig. 8
160mm, 6 1/4"



TW4-36
Fig. 9
160mm, 6 1/4"



TW4-37
Fig. 10
160mm, 6 1/4"

DIEFFENBACH
160mm, 6 1/4"



TW4-38
Fig. 15
160mm, 6 1/4"



TW4-39
Fig. 16
160mm, 6 1/4"

- Роторасширители
- Ecarteurs - Ouvre-bouches
- Vestibulumabhalter / Mundspanner
- Роторозширювачі
- Separadores - Abre-bocas
- الكاشطات - الكاشطات الفم



TW4-40
HMG
Heister
130mm



TW4-41
Mouth Gag Molt
110mm for (Children)



TW4-42
Mouth Gag Molt
140mm for (Adults)



TW4-43 140mm
TW4-44 180mm
Cheek Retractor



TW4-45 140mm
Cheek Retractor



TW4-46
Wangen Holder
150mm, with or without
lip protection



TW4-47
Wangen Holder
150mm, with
or without lip protection



TW4-48
Wangen holder
Wangen holder with dual
function, 170mm

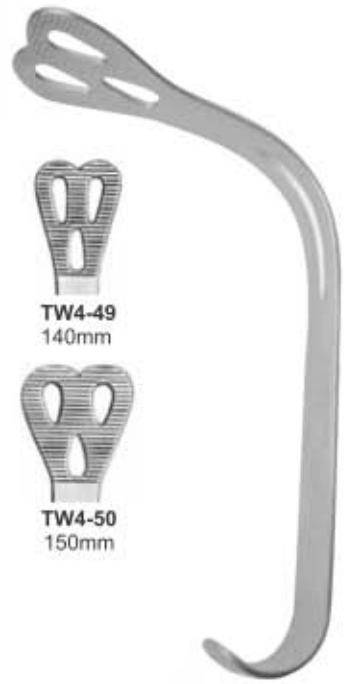

TW4-49
140mm



TW4-50
150mm

Cheek Retractor

RETRACTORS - MOUTH GAGS



- Роторасширители
- Ecarteurs - Ouvre-bouches
- Vestibulumabhalter / Mundspanner
- Роторозширювачі
- Separadores - Abre-bocas
- الكاشطات - الكمامات القم



TW4-51 105mm
TW4-52 135mm
Weitlaner
Fig. 1



TW4-53 105mm
TW4-54 135mm
Weitlaner
Fig. 2



TW4-55
Stainless Steel
Double
Ended Cheek
Retractors



TW4-56
Stainless Steel
Single
Ended Cheek
Retractors



TW4-57 110mm
TW4-58 130mm
TW4-59 150mm
Weitlander



TW4-60 110mm
TW4-61 130mm
TW4-62 150mm
Jennings



TW4-63
Denhard
120mm



TW4-64
Roser-Konig
160mm



TW4-65
Roser-Konig
190mm

- Ранорасширители
 - Ecarteurs
 - Wundhaken
- Ранорозширювачі
 - Separadores
 - الكاشطات

RETRACTORS



TW4-66
Cheek Retractor
Long



TW4-67
Cheek Retractor
Long



TW4-68
Cheek Retractor
Long



TW4-69
Retractor with
Ergo Grip
240mm
ergonomic handle



TW4-70
Cheek Retractor
Ivory
Width adjustable
& flexible, 200mm



TW4-71
Cheek Retractor
Tongue Depressor
190mm



TW4-72
Cheek Retractor
Minnesota
160mm



TW4-73
Cheek Retractor
200mm
Easy to Bend
by Hand



TW4-74
Cheek Retractor
Retractor and Tongue
Pushers Bishop with
Comfortable Margin,
160mm



TW4-75
Cheek Retractor
Retractor Combination
250mm

RETRACTORS



- Ранорасширители
- Ecarteurs
- Wundhaken

- Ранорозширювачі
- Separadores
- الكاشطات



TW4-76
Unique Retractor
Length 175mm
angled 45 °



TW4-77
Unique Retractor
Length 175mm
angled 90°



TW4-78
Retractor
160mm



TW4-79
Retractor
190mm



TW4-80
Mini-Langenbeck Retractor
160mm, Hooks 22 mm



TW4-81
Cheek Retractor
Retractors Combination
210mm, 2 Pcs



TW4-82
Mini Retractor
About 80mm



TW4-83
Retractor
170mm, Hooks 22 mm

- Ранорасширители
 - Ecarteurs
 - Wundhaken
- Ранорозширювачі
 - Separadores
 - الكاشطات



TW4-84
Surgical-flat Retractor
210mm, hook
30x16 mm



TW4-85
Surgical-flat Retractor
210mm, hook
42x11 mm



TW4-86
Surgical-flat Retractor
210mm, hook
60x12 mm



TW4-87 30x11 mm
TW4-88 30x16 mm
Langenbeck Retractor
210mm, hook



TW4-89
Retractor
210mm



TW4-90
Farabeuf
(120 X 12mm)



TW4-91
Seldin Retractor



TW4-92
Feldman
Retractor
140mm 5 1/2"

GUM SCISSORS



- Ножницы десневые
- Ciseaux a gencives
- Zahnfleischscheren
- Ножниц для ясен
- Tijeras para encias
- مقص صمغ



TW4-93
Iris
120mm
Straight



TW4-94
Iris
120mm
Curved



TW4-95
Micro Iris
90mm
Straight



TW4-96
Micro Iris
90mm
Curved



TW4-97
Iris
115mm
Curved



TW4-98
Iris
110mm
Straight



TW4-99
Iris
110mm
Curved



TW4-100
Angular, Saw edge
115mm



TW4-101
Angular
115mm



TW4-102 140mm Straight
TW4-103 200mm Straight
TW4-104 140mm Curved
TW4-105 200mm Curved
Metzenbaum

- Ножницы десневые
- Ciseaux a gencives
- Zahnfleischscheren
- Ножиці для ясен
- Tijeras para encias
- مقص صمغ



TW4-106
Goldman-Fox
130mm
Saw edge,
straight



TW4-107
Goldman-Fox
130mm
Saw edge,
curved



TW4-108
Goldman-Fox
130mm
Saw edge,
double curved



TW4-109
La Grange
115mm
Saw edge,
double curved



TW4-110
Neumann
120mm
Saw edge,
double curved



TW4-111
Kilner (Ragnell)
120mm
Straight



TW4-112
Kilner (Ragnell)
120mm
Curved



TW4-113
Joseph
140mm
Straight

GUM SCISSORS



- Ножницы десневые
- Ciseaux a gencives
- Zahnfleischscheren
- Ножниц для ясен
- Tijeras para encias
- مقص صمغ



TW4-114
Joseph
140mm
Curved



TW4-115
Kelly
160mm
Straight



TW4-116
Kelly
160mm
Curved



TW4-117
Locklin
160mm
Saw edge,
angular



Locklin
TW4-118 120mm
TW4-119 160mm
Saw edge,
angular



TW4-120
Dean
170mm
Saw edge,
angular

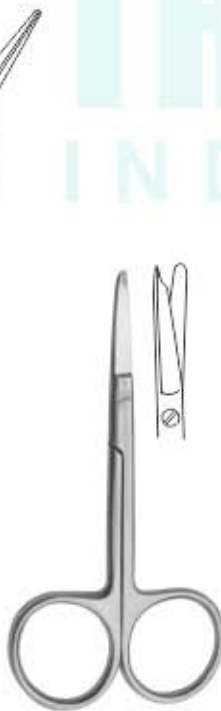

TW4-121
Spencer
90mm



TW4-122
Spencer
130mm



TW4-123
Spencer
115mm



TW4-124
Straight
120mm

- Ножницы десневые
 - Ciseaux a gengivas
 - Zahnfleischscheren
- Ножиці для ясен
 - Tijeras para encias
 - مقص صمغ



TW4-125
Straight
115mm



TW4-126
Curved
115mm



Straight
TW4-127 140mm
TW4-128 160mm
TW4-129 180mm



Mayo
TW4-130 140mm
TW4-131 160mm
TW4-132 180mm
Straight
TW4-133 140mm
TW4-134 160mm
TW4-135 180mm
Curved



Mayo
TW4-136 140mm
TW4-137 200mm
Straight
TW4-138 140mm
TW4-139 200mm
Curved



TW4-140
Noyes
110mm, Straight



TW4-141
Noyes
110mm
Curved



TW4-142
Noyes
110mm
Angular



TW4-143
Castroviejo
150mm
Curved



TW4-144
155mm

TRUEWIN
INDUSTRIES

CROWN SCISSORS



- Ножницы для короны
- Ciseaux de couronne
- Krone Schere
- Корональні ножиці
- Tijeras de la corona
- مقص التاج

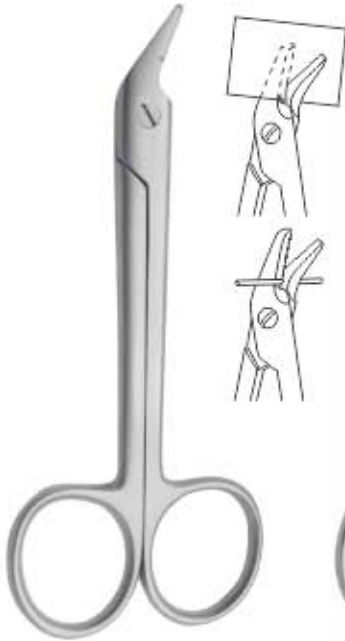

TW4-145
Universal
120mm
Saw edge



TW4-146
Beebee
110mm
Saw edge, straight



TW4-147
Beebee
110mm
Saw edge, curved



TW4-148
Beebee
120mm
Saw edge, straight



TW4-149
Beebee
120mm
Saw edge, curved



TW4-150 90mm
TW4-151 110mm
TW4-152 140mm
TW4-153 180mm
TW4-154 240mm
Lister Bandage Scissors



TW4-155
Dental scissors
large 175mm



TW4-156
180mm
universal
autoclavable up to
143 °C

- Ножницы десневые
 - Ciseaux a gencives
 - Zahnfleischscheren
- Ножниц для ясен
 - Tijeras para encias
 - مقص صمغ

T.C GOLD



TW4-157
Iris
110mm
Straight



TW4-158
Iris
110mm
Curved



TW4-159
Goldman-Fox
130mm
Saw edge, straight



TW4-160
Goldman-Fox
130mm
Saw edge, Curved

TRUEWIN
INDUSTRIES



TW4-161
La Grange
115mm
Saw edge,
double Curved



Mayo
TW4-162 140mm
TW4-163 170mm
TW4-164 230mm
Straight



Mayo
TW4-165 140mm
TW4-166 170mm
TW4-167 230mm
Curved

GUM SCISSORS



- Ножницы десневые
- Ciseaux a gencives
- Zahnfleischscheren
- Ножіці для ясен
- Tijeras para encias
- مقص صمغ

T.C GOLD



Metzenbaum
TW4-168 145mm
TW4-169 180mm
TW4-170 200mm
Straight



Metzenbaum
TW4-171 145mm
TW4-172 180mm
TW4-173 200mm
Curved



TW4-174
Kelly
160mm
Straight



TW4-175
Kelly
160mm
Curved



TW4-176
Universal
120mm



TW4-177
Beebee
110mm
Saw edge,
straight



TW4-178
Beebee
110mm
Saw edge,
curved



TW4-179
Beebee
120mm
Saw edge,
straight



TW4-180
Beebee
120mm
Saw edge,
curved

- Зажимы артериальные
 - Pincas hemostaticas
 - Arterienklemmen
- Затискачи артериальни
 - Pinzas hemostaticas
 - منقط ڄاموستانڪ



Hartmann (Baby Mosquito)
TW4-181 100mm straight
TW4-182 100mm curved



Halstead Mosquito
TW4-183 125mm straight
TW4-184 125mm curved



Halstead Mosquito 1x2
TW4-185 125mm straight
TW4-186 125mm Curved



Kelly
TW4-187 140mm straight
TW4-188 140mm curved



Rochester-Pean
TW4-189 140mm
TW4-190 160mm
TW4-191 180mm
TW4-192 200mm straight
TW4-193 140mm
TW4-194 160mm
TW4-195 180mm
TW4-196 200mm curved



Rochester-Kocher 1x2
TW4-197 140mm
TW4-198 160mm
TW4-199 180mm
TW4-200 200mm straight
TW4-201 140mm
TW4-202 160mm
TW4-203 180mm
TW4-204 200mm curved



Kelly-Rankin
TW4-205 160mm straight
TW4-206 160mm curved



TW4-207
 Heiss
 200mm curved

HAEMOSTATIC FORCEPS & TOWEL CLAMPS



- Зажимы артериальные, зажимы для салфеток
- Pincers hemostatiques, Pincers a compresas
- Arterienklemmen, Tuschklemmen
- Затискачі артеріальні, затискачі для серветок
- Pinzas hemostaticas, Pincers para compresas
- الملقط هيموستاتيک المشابك مختلفة

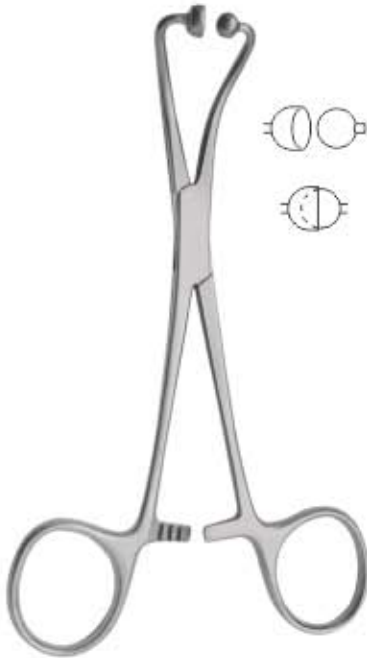

TW4-208
Backhaus
Not-perforating and
not-damaging 140mm



TW4-209
Backhaus
130mm

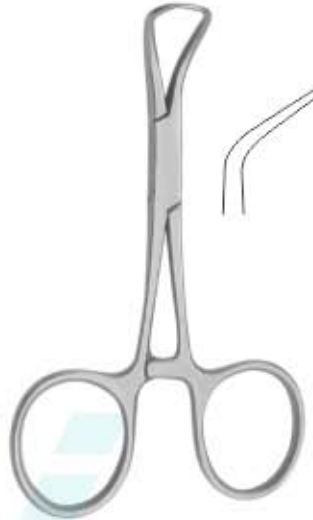

TW4-210
Backhaus
85mm



TW4-211
Jones
90mm

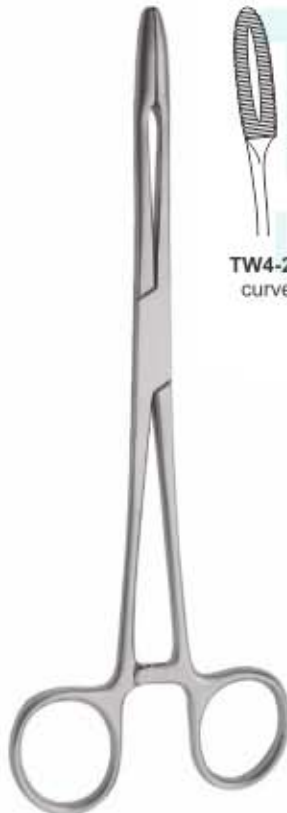

TW4-212
Gross Maier
Dressing Forceps
200mm straight



TW4-213
curved



TW4-214
Foerster
Dressing Forceps
200mm



TW4-215
Young
Tongue Forceps
170mm



Spare rubber



TW4-216
Collins
Tongue Forceps
170mm

- Стерилизационные и тканевые зажимы
- Stérilisation et pinces pour tissu
- Esterilizadores y sujetadores de tejidos

- Стерилізаційні та тканинні затискачі
- Esterilização e grampos de tecido
- تعقيم و المشابك الأنسجة



Cheattle
TW4-217 270mm



Rogge
TW4-218 200mm
TW4-219 300mm



Lorna
TW4-220 100mm
TW4-221 130mm



TW4-222
Allis-Baby 3:4
150mm



TW4-223
Allis 4:5
200mm



TW4-224
Allis 6:7
200mm

NEEDLE HOLDERS



- Иглодержатели
- Porte-aiguilles
- Nadelhalter

- Голкотримачи
- Porta-agujas
- اصحاب ابرة

T.C GOLD



- Иглодержатели
- Porte-aiguilles
- Nadelhalter

- Голкотримачи
- Porta-agujas
- اصحاب ابرة

T.C GOLD



Mathieu-Kocher



TW4-238
140mm



TW4-239
170mm



TW4-240
140mm



TW4-241
170mm



Mathieu



TW4-242
140mm



TW4-243
170mm



TW4-244
Olsen-Hegar Needle
Holder With Scissors
140mm



TW4-245
Gillies Needle
Holder With Scissors
160mm



Castroviejo
TW4-246 140mm straight
TW4-247 180mm straight
TW4-248 140mm curved
TW4-249 180mm curved



Castroviejo
TW4-250 140mm straight
TW4-251 180mm straight
TW4-252 140mm curved
TW4-253 180mm curved

NEEDLE HOLDERS



- Иглодержатели
- Porte-aiguilles
- Nadelhalter

- Голкотримачи
- Porta-agujas
- اصحاب ابرة



Castroviejo

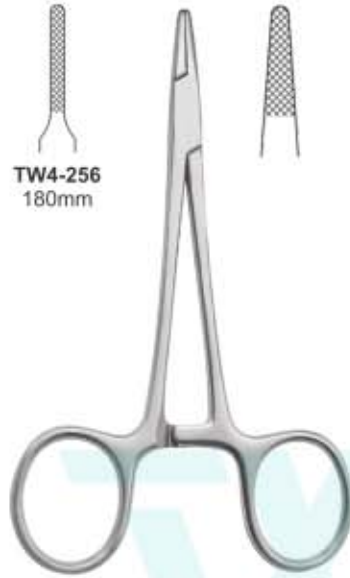
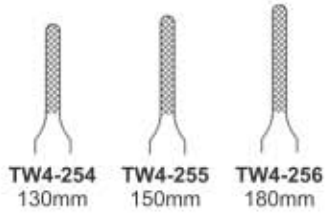

TW4-257
Halsey
130mm



TW4-258
Baumgartner
130mm



TW4-259
Derf
120mm



TW4-260
Delicate
150mm



TW4-261
Adson
170mm



Mayo-Hegar
TW4-262 130mm
TW4-263 160mm
TW4-264 180mm
TW4-265 200mm



TW4-266
Crile-Wood
150mm

- Иглодержатели
 - Porte-aiguilles
 - Nadelhalter
- Голкотримачи
 - Porta-agujas
 - اصحاب ابرة



TW4-267
Olsen-Hegar Needle
Holder With Scissors
140mm



TW4-268
Gillies Needle
Holder With Scissors
160mm



TW4-269
140mm

Mathieu



TW4-270
170mm



TW4-271
200mm



Mathieu-Kocher



TW4-272
140mm



TW4-273
170mm



TW4-274
Boynton
120mm



RUBBER DAM CLAMPS FORCEPS



- Инструменты для системы коффердам
- Pinces porte-crampons a digue
- Kofferdam Klammerzangen
- Инструменти для системи коффердам
- Pinzas de engrapar para dique de caucho
- المد العظام المنقط المشابك

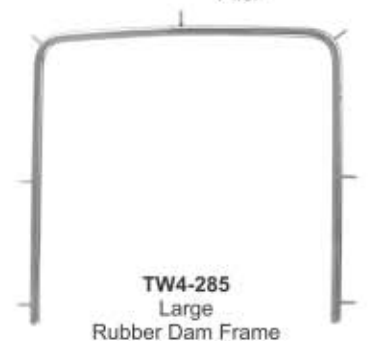
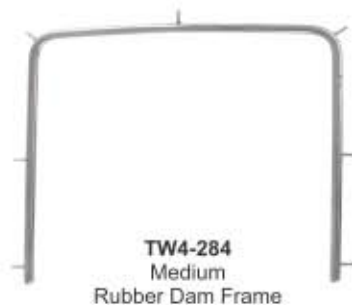
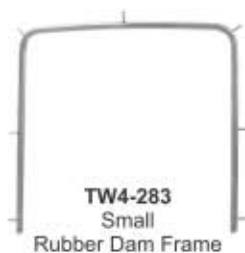
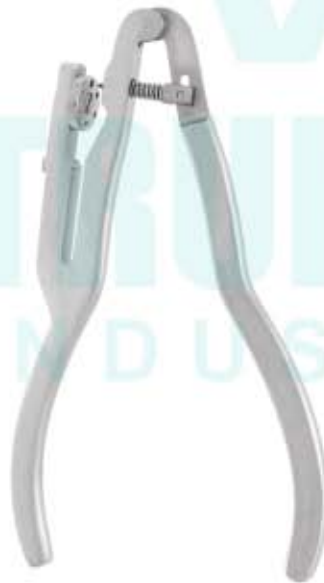

- Резиновая дамба зажимы комплекты
- Trousses de caoutchouc
- Gummidammklammern
- Гумова дамба затискачи комплекти
- Conjuntos de abrazaderas de retención de caucho
- المطاط المد المشابك مجموعات

Rubber Dam Kits



TW4-286

On request the Content of the rubber dam kit can be changed with other instruments.

Content:

- | | |
|------------------------------|------------------------------|
| 01 Anisworth | 08 Rubber Dam Clamp Fig. 212 |
| 02 Brewer | 09 Rubber Dam Clamp Fig. 211 |
| 03 Clamps Stand | 10 Rubber Dam Clamp Fig. 8 |
| 04 Rubber Dam Frame L | 11 Rubber Dam Clamp Fig. 8A |
| 05 Rubber Dam Frame M | 12 Rubber Dam Clamp Fig. 14 |
| 06 Rubber Dam Box Lower Case | 13 Rubber Dam Clamp Fig. 14A |
| 07 Rubber Dam Box Upper Case | 14 Rubber Dam Clamp Fig. 0 |
| | 15 Rubber Dam Clamp Fig. 00 |
| | 16 Rubber Dam Clamp Fig. 2 |
| | 17 Rubber Dam Clamp Fig. 2A |
| | 18 Rubber Dam Clamp Fig. 7 |

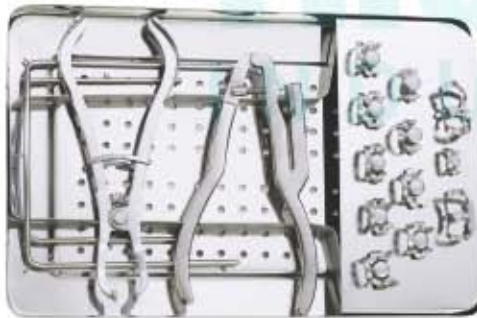

TW4-287

On request the Content of the rubber dam kit can be changed with other instruments.

Content:

- | | |
|------------------------------|------------------------------|
| 01 Ivory | 08 Rubber Dam Clamp Fig. 209 |
| 02 Ivory light weight | 09 Rubber Dam Clamp Fig. 212 |
| 03 Clamps Stand | 10 Rubber Dam Clamp Fig. 211 |
| 04 Rubber Dam Frame M | 11 Rubber Dam Clamp Fig. 8 |
| 05 Rubber Dam Frame L | 12 Rubber Dam Clamp Fig. 8A |
| 06 Rubber Dam Box Lower Case | 13 Rubber Dam Clamp Fig. 14 |
| 07 Rubber Dam Box Upper Case | 14 Rubber Dam Clamp Fig. 14A |
| | 15 Rubber Dam Clamp Fig. 0 |
| | 16 Rubber Dam Clamp Fig. 00 |
| | 17 Rubber Dam Clamp Fig. 2 |
| | 18 Rubber Dam Clamp Fig. 2A |
| | 19 Rubber Dam Clamp Fig. 7 |

RUBBER DAM CLAMPS KITS



- Резиновая дамба зажимы комплекты
- Trousses de caoutchouc
- Gummidammklammern
- Гумова дамба затискачи комплекти
- Conjuntos de abrazaderas de retención de caucho
- المطاط المد المشابك مجموعات



TW4-288

Stainless Steel Gold Plated Rubber Dam Clamp Tray with 11 Different Clamps
Fig. 212, 211, 8, 8A, 14, 14A, 0, 00, 2, 2A, 7



TW4-289

Stainless Steel Rubber Dam Clamp Tray with 12 Different Clamps
Fig. 209, 212, 211, 8, 8A, 14, 14A, 0, 00, 2, 2A, 7



TW4-290

Stainless Steel Rubber Dam Clamp Tray with 8 Different Clamps
Fig. 1, 26, 29, 51, 60, 202, 205, 210



TW4-291

Stainless Steel Rubber Dam Clamp Tray
(without clamps)

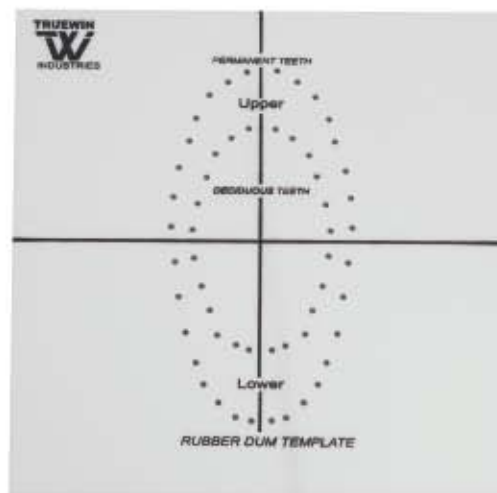

TW4-292
Rubber Dam Template

- Кляммера для коффердама
 - Clampons pour digue
 - Kofferdam Klammern
- Кляммера для коффердама
 - Grapas para dique de caucho
 - المشابك السد المطاط



TW4-293
Fig. 15



TW4-294
Fig. 18



TW4-295
Fig. 24



TW4-296
Fig. 25



TW4-297
Fig. 26



TW4-298
Fig. 28



TW4-299
Fig. 30



TW4-300
Fig. 31



TW4-301
Fig. 51



TW4-302
Fig. 138



TW4-303
Fig. 139



TW4-304
Fig. 200



TW4-305
Fig. 201



TW4-306
Fig. 202



TW4-307
Fig. 203



TW4-308
Fig. 204



TW4-309
Fig. 205



TW4-310
Fig. 3



TW4-311
Fig. W3



TW4-312
Fig. 4



TW4-313
Fig. 56A



TW4-314
Fig. 7



TW4-315
Fig. 7A



TW4-316
Fig. 8



TW4-317
Fig. 8A



TW4-318
Fig. W8A



TW4-319
Fig. 10



TW4-320
Fig. 11



TW4-321
Fig. 12A



TW4-322
Fig. 13A



TW4-323
Fig. 14



TW4-324
Fig. 14A



TW4-325
Fig. 14AN



TW4-326
Fig. 22



TW4-327
Fig. 27



TW4-328
Fig. 207



TW4-329
Fig. 29



TW4-330
Fig. 206



TW4-331
Fig. 208



TW4-332
Fig. 209



TW4-333
Fig. 1



TW4-334
Fig. 1A



TW4-335
Fig. 2



TW4-336
Fig. 2A



TW4-337
Fig. W2A



TW4-338
Fig. 0



TW4-339
Fig. 00



TW4-340
Fig. 210



TW4-341
Fig. 211



TW4-342
Fig. 212



TW4-343
Fig. 6



TW4-344
Fig. 9



TW4-345
Fig. N06



TW4-346
Fig. U67



TW4-347
Fig. P1



TW4-348
Fig. P2



TW4-349
Fig. G-1



TW4-349
Fig. G-1



TW4-350
Fig. G-2



TW4-350
Fig. G-2

CROWN REMOVER



- Инструменты для удаления коронок
 - Arrache-couronnes
 - Teleskopkronenzangen
- Инструменты для видалення коронок
 - Arranca-corona
 - مزيلات التاج



TW4-351
Crown Spreaders



TW4-352
Mershon
140mm
Band Pusher



TW4-353
Crown Spreader



TW4-354
Crown Remover



A



B



TW4-355
Crown Remover



A



B



C



D



TW4-356
Crown Remover



A



B



TW4-357
Crown Remover



A



B



C



D



E

- Прочие товары
- Divers produits et services
- Sonstige Produkte

- Інші товари
- Varios Productos
- المنتجات المتنوعة



TW4-358
X Ray Film Hanger



TW4-359
X Ray Film Hanger



TW4-360
X Ray Film Hanger



TW4-361
X Ray Film Hanger



TW4-362
Napkin Holder with
Plastic Chain



TW4-363
Napkin holder with metal chain



TW4-364
Mouth Props
Small

TW4-365
Mouth Props
Medium

TW4-366
Mouth Props
Large

Key Rings



TW4-367



TW4-368



TW4-369



TW4-370



TW4-371



TW4-372

- Матрицедержатели
 - Porte Matrices
 - Matrizenspanner
- Матрицеутримувачи
 - Porta Matrices
 - مصفوفة الخدم

Siqveland Retainers



TW4-373
5mm
TW4-374
6mm
Ivory 8



TW4-375
7mm
Ivory 8



TW4-376
Nystrom
Left



TW4-377
Nystrom
Right



TW4-378
Narrow



TW4-379
Wide



TW4-380
Fig. 1
Tofflemire-Universal



TW4-381
Fig. 2
Tofflemire-Junior



TW4-382
Fig. 3
Tofflemire-Senior



TW4-383
Ivory
with shields



TW4-384
Ivory
without shields



TW4-385
Ivory



TW4-386
Elliot



Amalgam Well

TW4-387
Stainless Steel
Amalgam Well

TRUEWIN
INDUSTRIES

- Инструменты для амальгамы
 - Instruments pour amalgame
 - Amalgamisinstrumente
- Инструменти для амальгами
 - Instrumentos para amalgama
 - الصكوك المثلغم



TW4-388
Fig. 10
165mm
English pattern



TW4-389
Fig. 1
185mm
German pattern



TW4-390
Fig. 1
150mm
Swiss pattern



TW4-391
Fig. 1
150mm



TW4-392
Fig. 2
150mm, 45°



TW4-393
Fig. 3
140mm, 90°



TW4-394
Chip Blower



TW4-395



TW4-396



TW4-397



TW4-398
Water Syringe

- Инструменты для амальгамы
- Instruments pour amalgame
- Amalgamis/strumente
- Инструменти для амальгами
- Instrumentos para amalgama
- الصكوك المثلغ

AMALGAM CARRIERS

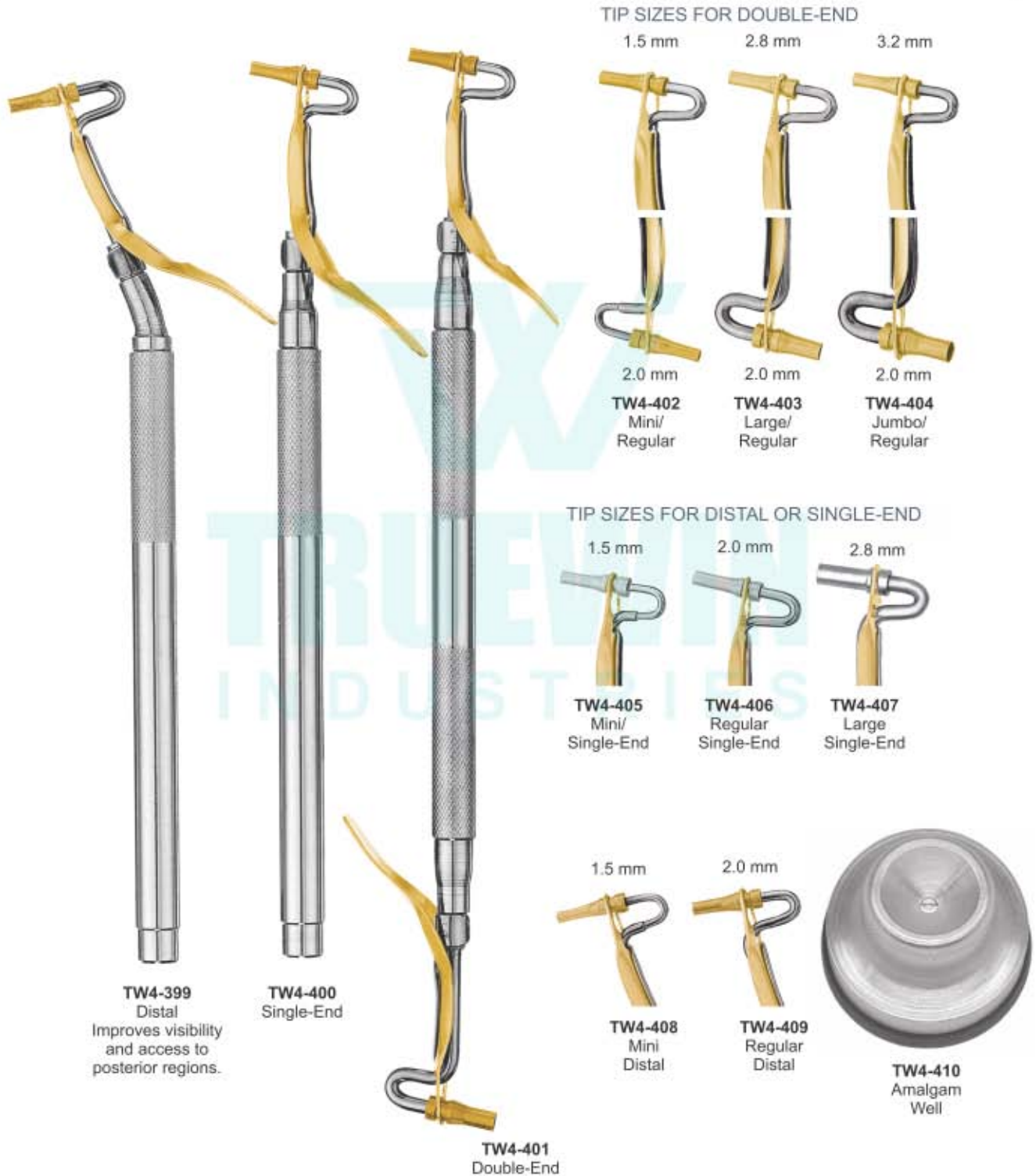

ROOT PLANNING CHISELES & BONE FILES



BONE FILES

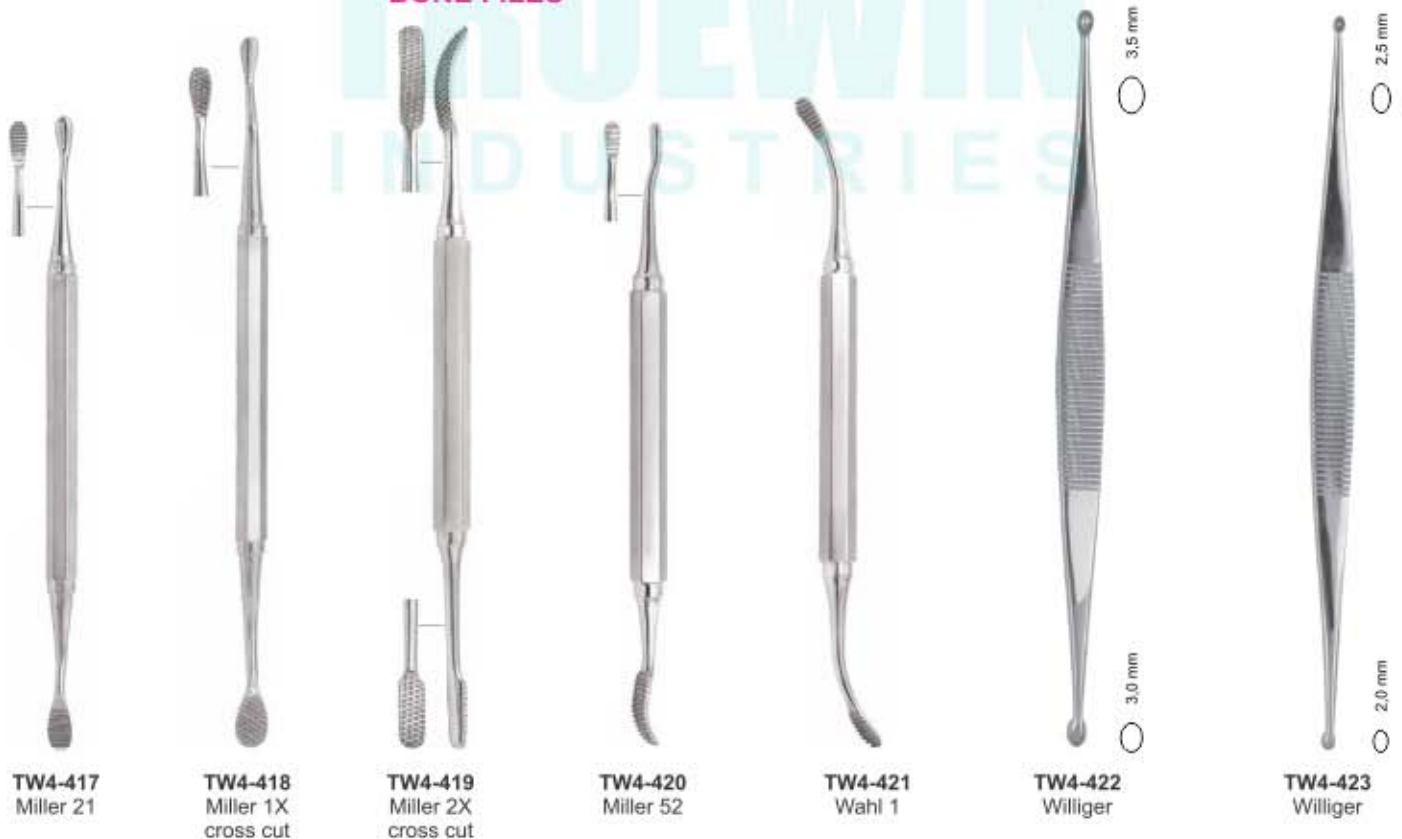

PERIODONTAL INSTRUMENTS



- Инструменты пародонтологические
- Instruments pour la parodontologie
- Instrumente für die Parodontologie
- Инструменти пародонтологічні
- Instrumentos para periodoncia
- الصوك للثة



TW4-424
1
Ochszenbin

TW4-425
2
Ochszenbin



TW4-426
Wakefield 1W
170mm

TW4-427
Wakefield 2W
170mm



ø 28 mm
Teflon
interchangeable
inserts
Autoclavable.

TW4-428
Mead
190 mm



ø 26 mm
With
interchangeable
inserts

320 gr – 11 ¼ oz

TW4-429
Mead
170 mm



ø 22 mm
Lead filled
200 gr – 7 oz

TW4-430
Partson
180mm



Partsch 140 mm
TW4-431 3mm
TW4-432 4mm
TW4-433 5mm
TW4-434 6mm

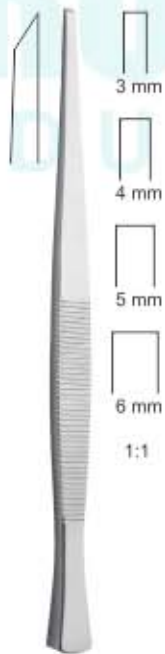

Partsch 170 mm
TW4-435 3mm
TW4-436 4mm
TW4-437 5mm
TW4-438 6mm



Partsch 140 mm
TW4-439 3mm
TW4-440 4mm
TW4-441 5mm
TW4-442 6mm



Partsch 170 mm
TW4-443 3mm
TW4-444 4mm
TW4-445 5mm
TW4-446 6mm

- Инструменты пародонтологические
- Instrumente für die Parodontologie
- Instrumenti parodontologici
- Instrumentos para periodoncia
- الصوك اللثة

PERIOSTEEL ELEVATORS



TW4-447
BUSER



TW4-448
Ohi 10



TW4-449
Howard 9H



TW4-450
Allen 9A



TW4-451
Prichard 3



TW4-452
Seldin 23



TW4-453



TW4-454
Raspator, Raspatory
Length 175mm



TW4-455



TW4-456



TW4-457
Raspator, Williger
Length 170mm, different widths
(4mm, 5mm or 7mm)



TW4-458



TW4-459
Trelat
140mm

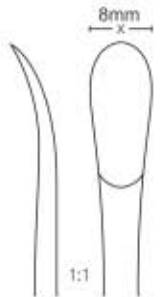

PERIODONTAL INSTRUMENTS



- Инструменты пародонтологические
- Instruments pour la parodontologie
- Instrumente für die Parodontologie
- Инструменти пародонтологічні
- Instrumentos para periodoncia
- الصكوك للتانة



TW4-460
Freer



TW4-461
Freer 15



TW4-462
Freer 16



TW4-463
Goldman-Fox
14



TW4-464
P 24G



TW4-465
Molt
175mm



TW4-466
Molt
175mm



TW4-467
Meat
175mm



TW4-468
Meat
175mm



TW4-469
Meat
175mm

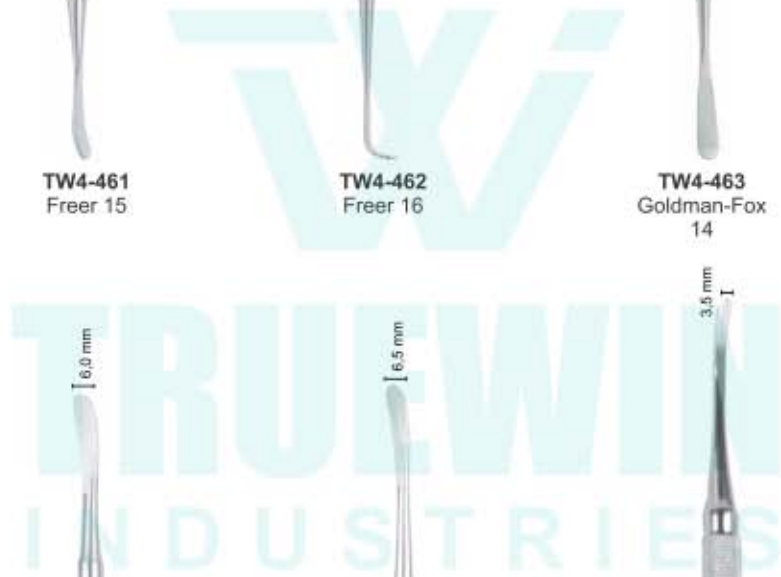

- Шприцы стоматологические карпульные
 - Seringues à usage dentaire
 - Dentalspritzen
- Шприці стоматологічні карпульні
 - Jeringas dentales
 - المحاقن الأسنان



TW4-470
Type A
1,8ml.



TW4-471
Type C
1,8ml.



TW4-472
Type C
1,8ml.



TW4-473
Type Euro
1,8ml.



TW4-474
3-Ring
1,8ml.



TW4-475
2-Ring
1,8ml.

DENTAL SYRINGES



- Шприцы стоматологические карпульные
- Seringues à usage dentaire
- Dentalspritzen
- Шприці стоматологічні карпульні
- Jeringas dentales
- المحاقن الأسنان



TW4-476
Euro
Breech loading
1,8ml.



TW4-477
Euro
Breech loading
1,8ml.



TW4-478
Manual Aspirating Syringe
1,8ml.



TW4-479
Quatro
1,8ml.



TW4-480
Trio
1,8ml.

- Шприцы стоматологические карпульные
- Seringues à usage dentaire
- Dentspritzen
- Шприці стоматологічні карпульні
- Jeringas dentales
- المعاقن الأسنان



TW4-481
Pistol-Ject
1,8ml.
injects 0.20ml with every click
Lever action for high injection pressure

Autoclavable



TW4-486
Fig. 1001
Intraligamental
Anesthesia Syringe in
Black Colour Auto
Cleavable

Autoclavable



TW4-482
Ject Ultima
1,8ml.
Injects 0,05 ml with every click
Supplied with angled and straight tubes



TW4-487
Disc System
1,8ml.



TW4-488
Disc System
1,8ml.



TW4-483
Swedish Type
1,8ml.



TW4-489
Disc System
1,8ml.



TW4-484
Ject angled
1,8ml.



TW4-490
Projection System
1,8ml.



TW4-485
Ject straight
1,8ml.



TW4-491
Projection System
1,8ml.

DENTAL SYRINGES



- Шприцы стоматологические карпульные
- Seringues à usage dentaire
- Dentspritzen
- Шприці стоматологічні карпульні
- Jeringas dentales
- المحاقن الأسنان



TW4-492
Aluminium - Dark
1.8 ml



TW4-493
Aluminium - Silver
1.8 ml



TW4-494
Aluminium - Orange
1.8 ml



TW4-495
Aluminium - Green
1.8 ml



TW4-496
Aluminium - Blue
1.8 ml

- Костные кусачки
- Hohlmelbelzangen
- Pincès-gouges
- Кусачки для кісток
- Pinzas-gubias
- روتجورس العظام



TW4-497
Blumenthal
155 mm



TW4-498
Blumenthal 45°
150 mm



TW4-499
Blumenthal 90°
140 mm



TW4-500
Micro Luer
150 mm



TW4-501
Luer
150 mm



Kerrison

BONE ROUNGER



- Костные кусачки
- Hohlmeißelzangen
- Pincès-gouges
- Кусачки для кісток
- Pinzas-gubias
- روتچورس العظام



TW4-503
Friedman
140 mm



TW4-504
Micro Friedman
145 mm



TW4-505
Micro Friedman 90°
145 mm



TW4-506
Lempert Delicate
160 mm



TW4-507
Cleveland
155 mm



TW4-508
Beyer
170 mm

- Костные кусачки
 - Hohlmeißelzangen
 - Pincès-gouges
- Кусачки для кісток
 - Pinzas-gubias
 - روتجورس العظام



TW4-509
Fig. 40
Ruskin

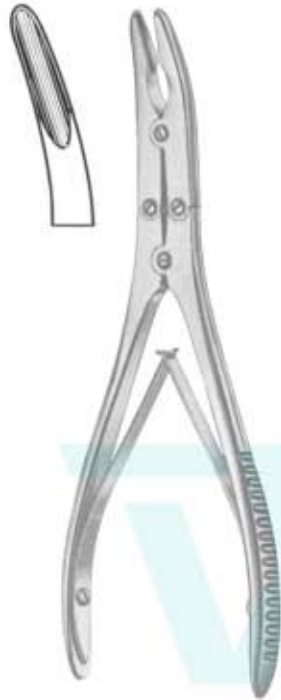

TW4-510
Fig. 41
Beyer



TW4-511
Fig. 50
Liston
140mm



TW4-512
Fig. 51
Liston
190mm

TRUEWIN
INDUSTRIES



TW4-513
Tomati
120mm

CROWN REMOVER



- Инструменты для удаления коронок
 - Arrache-couronnes
 - Teleskopkronenzangen
- Инструменты для видалення коронок
 - Arranca-corona
 - مزيلات التاج



TW4-514
160 mm

Crown Plier with plastic inserts Straight
For ceramical and plastic crowns and bridges, with
plastic inserts (sterilization up to 180° C).



TW4-515
145 mm

Crown Plier
with plastic inserts
Angled



TW4-516
140 mm

Universal plier for the removal
of ceramic crowns and bridges



TW4-517
Furrer
Copper Ring
Removing Plier.
150 mm
Curved



TW4-518 125 mm
TW4-519 150 mm
Böhm
Pliers for telescope
crowns.
Diamond points
coated.

• Молотки, ножницы, пилы и лезвия

• Молотки, ножиці, пилки і леза

• شفرات مناشير - الحصص المقصات - مطارق



TW4-520
Metal tip
220 mm

Hammer With Wooden Handle



TW4-521
Metal tip
220 mm



TW4-522
1
For plaster



TW4-523
2
For metal



TW4-524
Fret saw
250 mm



TW4-525
Small
Saw Blades



TW4-526
Large
Saw Blades



TW4-527
Ceri Saw



TW4-528
Plaster Shears
200 mm



Crucible Tongs
TW4-529 250 mm
TW4-530 320 mm



TW4-531
Ceri Saw
180 mm



TW4-532
Blade
0,12x5 mm
Conf. 12 pcs



TW4-533
Blade
0,25x5 mm
Conf. 12 pcs



TW4-534
Blade
0,25x3 mm
Conf. 12 pcs





Truewin orthodontics pliers in Clinical Dentistry Orthodontics and Dentofacial Orthopaedics

Driven by the demand for tooth alignment, general practitioners are increasingly being asked to provide orthodontic treatment.

Dentists keen to participate in this area of expertise need to demonstrate the skills to identify suitable patients, the ability to provide conventional and contemporary orthodontic treatment and be aware of its limitations.

This is exactly what this programme delivers, along with the vital core competencies to excel in this unique postgraduate area.

The objective of the Truewin in Orthodontics and Dentofacial Orthopaedics is to provide dental surgeons with the core knowledge and clinical skills essential for the delivery of competent, high-quality dental care.

It encompasses a blended learning approach and consists of a combination of lectures, seminars, workshops, clinical case discussions and laboratory sessions.

The flexible modular structure enables the programme to meet a wide range of student needs.



ORTHODONTIC INSTRUMENTS



- Инструменты ортодонтические
- Instrumentos Ortodonticos
- Orthodontische Instrumente
- Инструменти ортодонтични
- Instruments Orthodontiques
- أدوات تقويم الأسنان



TW5-01
Height Gauge 0.18
Aluminum



TW5-02
Height Gauge 0.22
Aluminum



TW5-03
Height Gauge 0.18
Stainless Steel



TW5-04
Height Gauge 0.22
Stainless Steel



TW5-05
Moveable
Height Gauge



TW5-06A
Endo Finger
Ruler Span
Measure Scale



TW5-06
Bone Bracket Gauge



TW5-06B
Endo Finger
Ruler Span
Measure Scale



TW5-06C
Endo Finger
Ruler Span
Measure Scale



TW5-07
Bone Thickness Gauge
40mm, 180mm



TW5-08
Osteometer
Measuring Forceps For Jaw
Ridge Width measurement, scale
on both sides, rustfree, autoclavable



TW5-09
Positive
Postioner



TW5-10
Strip Saw



TW5-11
Endo Finger
Ruler
Span Measure Scale



TW5-12
Endo Finger
Ruler
Span Measure Scale

- Инструменты ортодонтические
- Instrumentos Ortodonticos
- Orthodontische Instrumente
- Инструменти ортодонтични
- Instruments Orthodontiques
- أدوات تقويم الأسنان



TW5-13
Direct bonding
bracket holders,
136mm



TW5-14
Direct bonding
bracket holders,
135mm



TW5-15
Direct Bond
Bracket Holder
Tweezers,
Small Tip
135mm



TW5-16
Direct bonding
bracket holders,
140mm



TW5-17
Deluxe Bracket
Holder Tweezers
135mm



TW5-18
Deluxe Bracket
Holder Tweezers
110mm



TW5-19
Deluxe Bracket
Holder Tweezers
135mm

ORTHODONTIC INSTRUMENTS



- Инструменты ортодонтические
- Instrumentos Ortodonticos
- Orthodontische Instrumente
- Инструменти ортодонтични
- Instruments Orthodontiques
- أدوات تقويم الأسنان



TW5-20
Elastic instruments



TW5-21
Twiel-on elastic module instrument



TW5-22
Schure Band Seater



TW5-23
Ortho light scaler



TW5-24
Ortho light scaler



TW5-25
Ortho instrument



TW5-26
Ortho instrument



TW5-27
Ligature instruments



TW5-28
Ligature instruments

- Инструменты ортодонтические
- Instrumentos Ortodonticos
- Orthodontische Instrumente
- Инструменти ортодонтични
- Instruments Orthodontiques
- أدوات تقويم الأسنان



TW5-29
Ortho Light double ended
ligature director



TW5-30
Ortho Light double ended ligature scaler director tivate coil spring
are remove modules with one instruments



TW5-31
Ortho band pusher scaler



TW5-32
Ortho ligature director single ended



TW5-33
Ortho Light double ended ligature scaler/director
tivate coil spring are remove modules with one instruments



TW5-34
Ortholite Ligature Director Scaler



TW5-35
Ortho light ligature director double ended



TW5-36
Double ended Tampers

ORTHODONTIC INSTRUMENTS



- Инструменты ортодонтические
- Instrumentos Ortodonticos
- Orthodontische Instrumente
- Инструменти ортодонтични
- Instruments Orthodontiques
- أدوات تقويم الأسنان



TW5-37
Band seater
auto cleavable



TW5-38
Band seater
auto cleavable
Triangle Shape



TW5-39
Band seater
auto cleavable
Square Shape



TW5-40
Band seater
auto cleavable
Round Shape



TW5-41
Mershon Band
Pusher
140mm



TW5-42
Band seating &
removing
instruments



TW5-43
Ortho Light double
ended
ligature director
scaler



TW5-44
Ortho Light Band
Pusher Scaler

- Щипцы для ортодонтии и протезирования
- Pincers pour l'orthodontie et la prothèse
- Zangen für Kieferorthopädie und Prothetik
- Щипці для ортодонції та протезування
- Alicates para ortodoncia y prótesis
- كمانة لتقويم الأسنان بروستھتیس



TW5-45
Aderer
Large wire bending
and loop forming pliers
130mm



TW5-46
Aderer Plier
For the manufacturing of appliances and
activation of wires for wires up to .030" fine
tip and up to .036" mean tip.
Length 130mm



TW5-47
Angle Plier
Fig. 1
135mm



TW5-48
Angle Plier
Fig. 2
140mm



TW5-49
Angle Plier
Fig. 3
130mm



TW5-50
Angle Plier
Fig. 4
140mm

PLIERS FOR ORTHODONTICS & PROSTHETICS



- Щипцы для ортодонтии и протезирования
- Щипці для ортодонтії та протезування
- Pincers pour l'orthodontie et la prothèse
- Alicates para ortodoncia y prótesis
- Zangen für Kieferorthopädie und Prothetik
- كمانة لتقويم الأسنان بروستھتیس



TW5-51
Adams Plier
Adams pliers for bending wire arches and bends right angles for wires up to .022", .025 tip to beak. Length 130mm



TW5-52
Flat Nose Pliers
140mm



TW5-53
Johnson Contouring Pliers
140mm



TW5-54
Falcon Beak
Contouring Pliers.
130mm



TW5-55
How Plier
Universally usable tool for the multiband technology for wires up to .028".
Length 145mm



TW5-56
How Plier curved
Universally usable tool for the multiband technology for wires up to .028".
Length 145mm

TRUEWIN
INDUSTRIES

- Щипцы для ортодонтии и протезирования
- Pincers pour l'orthodontie et la prothèse
- Zangen für Kieferorthopädie und Prothetik
- Щипці для ортодонції та протезування
- Alicates para ortodoncia y prótesis
- كمانة لتقويم الأسنان بروستھیس



TW5-57
De La Rosa
Fig. 1
135mm



TW5-58
Arch Counting Plier Grooved
for double back and triple back
bands in 0.30" / 0.76mm & 0.36"
/ 0.91mm lingual arch wires
135mm



TW5-59
Contouring Plier
Fig. 2
135mm



TW5-60
Nance Pliers
135mm



TW5-61
Tweed Loop
forming Pliers
140mm

3 mm
4 mm
5 mm
6 mm



TW5-62
Nance Loop
forming Pliers
140mm

- Щипцы для ортодонтии и протезирования
- Pincers pour l'orthodontie et la prothèse
- Zangen für Kieferorthopädie und Prothetik
- Щипці для ортодонції та протезування
- Alicates para ortodoncia y prótesis
- كمانة لتقويم الأسنان بروستھتیس



TW5-63
Tweed Loop Plier
130mm



TW5-64
Band Removing Plier
The curved blade of the band removing plier can strip easily and gently remove directly to the tooth. Length 140mm



TW5-65
Crown & Shell Plier
130mm



TW5-66
Young Wire Bending &
Loop Forming Pliers
135mm



TW5-67
Ligature Cutters T.C
Hard Wire
130mm



TW5-68
Mini Ligature Cutters T.C
Light Tip
130mm

- Щипцы для ортодонтии и протезирования
- Pincers pour l'orthodontie et la prothèse
- Zangen für Kieferorthopädie und Prothetik
- Щипці для ортодонції та протезування
- Alicates para ortodoncia y prótesis
- كمانة لتقويم الأسنان بروستھتیس



TW5-69
Mini Ligature cutters T.C
fine tip
130mm



TW5-70
Large
Fluch-cut distal and cutting Pliers T.C
with safety hold fitted with
un-breakable, corrosion
resistant and durable
stainless steel tips
130mm



TW5-71
Small
Fluch-cut distal and cutting Pliers T.C
with safety hold fitted with
un-breakable, corrosion
resistant and durable
stainless steel tips
130mm



TW5-72
Bracket Removing Plier
Bracket removing plier for comfortable
and quick removal of the brackets.
Length 135mm



TW5-73
Bracket Removing Plier curved
Bracket Removing Plier curved for
easy removal of brackets in the
posterior region. Length 145mm



TW5-74
Grooved Fine Plier
145mm

PLIERS FOR ORTHODONTICS & PROSTHETICS



- Щипцы для ортодонтии и протезирования
- Pincers pour l'orthodontie et la prothèse
- Zangen für Kieferorthopädie und Prothetik
- Щипці для ортодонції та протезування
- Alicates para ortodoncia y prótesis
- كمانة لتقويم الأسنان بروستھتیس



TW5-75
Aderer
Facebow loop forming Pliers
145mm



TW5-76
V Bending Pliers
135mm



TW5-77
Tweed / angle rectangular
arch forming & Torquing pliers
135mm



TW5-78
Weingart Plier medium
Weingart plier that are ideal due to
their curved tip for setting sheets and
is capable of bending the ends.
Length 145mm



TW5-79
Universal Plier
165mm



TW5-80
Jarabak Plier
145mm



- Щипцы для ортодонтии и протезирования
- Pincers pour l'orthodontie et la prothèse
- Zangen für Kieferorthopädie und Prothetik
- Щипці для ортодонції та протезування
- Alicates para ortodoncia y prótesis
- كمانة لتقويم الأسنان بروستيثيس



TW5-81
Waldsachs Wire Bending
and Cutting Pliers
150mm



TW5-82
Universal Dolphin Style
Wire Bending & cutting pliers



TW5-83
Arrow Clasp Forming Pliers
125mm, 5"

TW5-84
Schwarz
130mm



TW5-85
Flat Nose Pliers
both sides smooth
140mm



TW5-86
Flat Nose Pliers
both sides serrated
140mm



TW5-87
Peeso
Wire Bending Pliers
135mm



TW5-88
Goslee
Flat Nose Pliers
140mm



TW5-89
Flat Nose Pliers
both sides serrated
with TC 140mm inserts

- Щипцы для ортодонтии и протезирования
- Pincers pour l'orthodontie et la prothèse
- Zangen für Kieferorthopädie und Prothetik
- Щипці для ортодонції та протезування
- Alicates para ortodoncia y prótesis
- كمانة لتقويم الأسنان بروستھتیس



TW5-90
Universal Pliers
for soft and hard wire
160mm



TW5-91
Thick grooved plier
145mm



TW5-92
Bird's beak claw with cutter
130mm



TW5-93
Elastomeric Separator
Placing Pliers 160mm



TW5-94
For incisors with
convex beaks
160mm



TW5-95
For bicuspid
and molars
with concave beaks
160mm

- Щипцы для ортодонтии и протезирования
- Щипці для ортодонтії та протезування
- Pinces pour l'orthodontie et la prothèse
- Alicates para ortodoncia y prótesis
- Zangen für Kieferorthopädie und Prothetik
- كمانة لتقويم الأسنان بروستيثيس

L-KEY JOINT PLIERS T.C.



TW5-96
T.C Distal end cutter with safety hold, mini head, long handles.
fitted with un-breakable, corrosion resistant and durable stainless steel tips

- 0.30 mm to 0.50 mm (.012" to .020")
- Max. 0.46 mm x 0.64 mm (.018" x .025")
- ⊗ 0.38 mm to 0.53 mm (.0155" to .0215")
- ⊗ Max. 0.53 mm x 0.64 mm (.021" x .025")



TW5-100
T.C Soft wire and ligature cutter, 15° angled fitted with un-breakable, corrosion resistant and durable stainless steel tips

- ☞ .25 mm to .38 mm (.010" to .015")



TW5-97
T.C Flush-cut distal end cutter with safety hold fitted with un-breakable, corrosion resistant and durable stainless steel tips

- 0.30 mm to 0.50 mm (.012" to .020")
- Max. 0.46 mm x 0.64 mm (.018" to .025")



TW5-101
T.C Soft wire and ligature cutter, 45° angled fitted with un-breakable, corrosion resistant and durable stainless steel tips

- ☞ .25 mm to .38 mm (.010" to .015")



TW5-98
T.C Soft wire and ligature cutter, Mini fitted with un-breakable, corrosion resistant and durable stainless steel tips

- ☞ .25 mm to .38 mm (.010" to .015")



TW5-102
T.C Hard wire cutter, straight Fitted with un-breakable, corrosion resistant and durable stainless steel tips

- 0.30 mm to 0.50 mm (.012" to .020")
- Max. 0.56 mm x 0.71 mm (.022" x .028")



TW5-99
T.C Soft wire and ligature cutter, standard fitted with un-breakable, corrosion resistant and durable stainless steel tips

- ☞ .25 mm to .38 mm (.010" to .015")



TW5-104
T.C Hard wire cutter, 15° angled Non-autoclavable

- 0.30 mm to 0.50 mm (.012" to .020")
- Max. 0.56 mm x 0.71 mm (.022" x .028")

- Щипцы для ортодонтии и протезирования
- Pinces pour l'orthodontie et la prothèse
- Zangen für Kieferorthopädie und Prothetik
- Щипці для ортодонції та протезування
- Alicates para ortodoncia y prótesis
- كمانة لتقويم الأسنان بروستیتیس

L-KEY JOINT PLIERS T.C



TW5-105
T.C Band removing pliers



TW5-110
T.C Weingart-mini
Utility Pliers

- 0.30 mm to 0.50 mm (.012" to .020")
- Max 0.56 mm x 0.71 mm (.022" x .028")



TW5-106
T.C Bracket removing pliers angled



TW5-111
T.C Weingart
Utility Pliers

- 0.30 mm to 0.50 mm (.012" to .020")
- Max 0.56 mm x 0.71 mm (.022" x .028")



TW5-107
T.C Bracket removing pliers straight



TW5-112
T.C How Straight
Utility Pliers

- 0.30 mm to 0.50 mm (.012" to .020")
- Max 0.56 mm x 0.71 mm (.022" x .028")



TW5-108
T.C Bracket removing pliers with plastic tip



TW5-113
T.C How Angled
Utility Pliers

- 0.30 mm to 0.50 mm (.012" to .020")
- Max 0.56 mm x 0.71 mm (.022" x .028")



TW5-109
T.C Adhesive removing pliers



TW5-114
T.C Wire bending and loop forming pliers
Angled (Bird beak)

- 0.30 mm to 0.50 mm (.012" to .020")
- Max 0.56 mm x 0.71 mm (.022" x .028")

- Щипцы для ортодонтии и протезирования
- Pincers pour l'orthodontie et la prothèse
- Zangen für Kieferorthopädie und Prothetik
- Щипці для ортодонції та протезування
- Alicates para ortodoncia y prótesis
- كمانة لتقويم الأسنان بروستھتیس

L-KEY JOINT PLIERS T.C.



TW5-115
T.C Cinch Back / tie back
Distal end bending pliers

● 0.30 mm to 0.50 mm (.012" to .020")
■ Max. 0.56 mm x 0.71 mm (.022" x .028")



TW5-116
T.C Detailing step pliers / Bayonet
bending pliers - 1mm

● 0.30 mm to 0.50 mm (.012" to .020")
■ Max. 0.56 mm x 0.71 mm (.022" x .028")



TW5-117
T.C Stop pliers V-Bebd - 1mm

● 0.30 mm to 0.50 mm (.012" to .020")
■ Max. 0.43 mm x 0.56 mm (.017" x .028")



TW5-118
T.C Tweed / angel
Rectangular arch forming and
torquing pliers

● 0.30 mm to 0.71 mm (.012" to .028")
■ Max. 0.56 mm x 0.71 mm (.022" x .028")



TW5-119
T.C Surgical ball hook crimping
pliers, straight

L-KEY JOINT PLIERS Without T.C.



TW5-120
Multi-purpose pliers, bird beak,
De la rosa and cutter in one

● 0.30 mm to 0.50 mm (.012" to .020")
■ Max. 0.46 mm x 0.56 mm (.018" x .022")



TW5-121
Hammer head
Distal end bending pliers

● 0.30 mm to 0.50 mm (.012" to .020")
■ Max. 0.56 mm x 0.71 mm (.022" x .028")



TW5-122
Nance
Loop forming pliers

● 0.36 mm to 0.71 mm (.014" to .028")
■ Max. 0.56 mm x 0.71 mm (.022" x .028")



TW5-123
Lingual / palatal arch forming plies

● 0.76 mm (.030") / 0.91 mm (.036")



TW5-124
Torquing pliers



TW5-125
Surgical ball hook crimping pliers,
angled

- Щипцы для ортодонтии и протезирования
- Pincers pour l'orthodontie et la prothèse
- Zangen für Kieferorthopädie und Prothetik
- Щипці для ортодонції та протезування
- Alicates para ortodoncia y prótesis
- كمانة لتقويم الأسنان بروستیتیس

L-KEY JOINT PLIERS



TW5-126
Aderer Clamp three jaw wire bending plier for contouring and bending wire up to .30"/.76mm.



TW5-132
Falcon beak contouring plier.

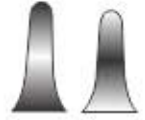

TW5-127
Bird beak plier for bending round, square and rectangle wire up to .30"/.76mm.

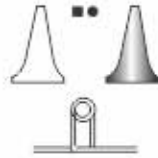

TW5-133
For placement and removal of arch wires, pins and other auxiliaries.



TW5-128
Bird beak plier for light wire bending round, square and rectangular up to .016"/0.41mm.

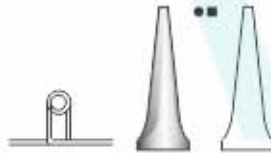

TW5-134
For placement and removal of arch wires, pins and other auxiliaries in angle design



TW5-129
Double Rounded jaw bending pliers, hooks and wire up to .020"/0.51mm.

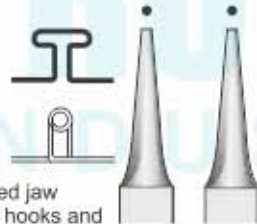

TW5-135
contouring Plier.



TW5-136
Bending plier. In order to skirt molares bands. With grooved. Recommended wire. 016", 018" and 022" 0.41mm, 0.46mm and 0.56mm



TW5-130
Adams pliers for hooks and bending wire up to .030"/0.76mm.

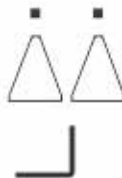

TW5-137
Loop forming in four length 3,4,5 & 6 mm wire capacity 0.22", 56mm.



TW5-131
Johnson pliers for crown band contouring



TW5-138
Arch bending plier design for convenient handling of square or rectangular wire, .020" / 0.51mm.





PLIERS FOR ORTHODONTICS & PROSTHETICS

- Щипцы для ортодонтии и протезирования
- Pincers pour l'orthodontie et la prothèse
- Zangen für Kieferorthopädie und Prothetik
- Щипці для ортодонції та протезування
- Alicates para ortodoncia y prótesis
- كمانة لتقويم الأسنان بروستھیس



TW5-139
Thermo Forming Pliers



TW5-140
Thermo Forming Pliers



TW5-141
Thermo Forming Pliers

- Щипцы для ортодонтии и протезирования
- Щипці для ортодонції та протезування
- Pinces pour l'orthodontie et la prothèse
- Alicates para ortodoncia y prótesis
- Zangen für Kieferorthopädie und Prothetik
- ڪمانڻو لئڙوڀم اسٽن پروسٽيٽس

LAP & L-KEY JOINT PLIERS



TW5-142
Pin & Ligature Cutters
TC. Gold.



TW5-143
Mini Pin & Ligature
Cutter TC. Gold.



TW5-144
Standard Ligature
Cutter TC. Gold.



TW5-145
Distal end Cutter
TC. Gold.



TW5-146
Hook Crimping Plier Angled
TC. Gold.



TW5-147
Distal end Cutter, Safety Hold Plier
(Ideal for Cutting Wire) TC. Gold.

- Щипцы для ортодонтии и протезирования
- Pincers pour l'orthodontie et la prothèse
- Zangen für Kieferorthopädie und Prothetik
- Щипці для ортодонції та протезування
- Alicates para ortodoncia y prótesis
- كمانة لتقويم الأسنان بروستھتیس

L-KEY JOINT PLIERS



TW5-148
Direct Bracket Remover
TC. Gold.



TW5-149
Straight Direct Bond Bracket
Remover T.C



TW5-150
Pin Holding Plier



TW5-151
3 Prong Clasp Adjustable
Plier TC. Gold.



TW5-152
Utility Plier Weingart TC. Gold.



TW5-153
Nance Plier TC. Gold.

- Щипцы для ортодонтии и протезирования
- Pincers pour l'orthodontie et la prothèse
- Zangen für Kieferorthopädie und Prothetik
- Щипці для ортодонції та протезування
- Alicates para ortodoncia y prótesis
- کمانچه لتقویم الاسنان پروستیتیس



TW5-154
Separating Pliers For Separators
155mm



TW5-155
Elastic
Separating Plier



TW5-156 Straight
TW5-157 Curved
Smaha Elastomeric ligature
placing forceps
140 mm



TW5-158
Elastomeric ligature placing
forceps with groove
Falcon 140 mm



TW5-159
Elastomeric ligature placing
forceps with groove
Falcon 140 mm

- Щипцы для ортодонтии и протезирования
- Pincers pour l'orthodontie et la prothèse
- Zangen für Kieferorthopädie und Prothetik
- Щипці для ортодонції та протезування
- Alicates para ortodoncia y prótesis
- كمانة لتقويم الأسنان بروستھتیس



TW5-160
Methieu Plier
With Ring



TW5-161
Pliers to Place Modules
140mm



TW5-162
Forceps For Placing Dentalastics
120mm



TW5-163
mathieu
140mm



TW5-164
Mathieu Ligature Pliers
140mm



TW5-165
Ligature Pliers T.C Gold
With Tungsten Carbide Inserts
140mm



Ligature Pliers
140mm

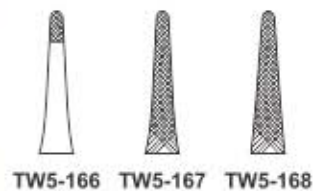

- Ортодонтия Щипцы Подставки
- Supports de pinces d'orthodontie
- Kieferorthopädie Zangenständer

- Ортодонтия Щипці Підставки
- KFO Zangen Ständer
- تقويم الأسنان كماشة تقف



TW5-169
Plier Stand
Stainless Steel.



TW5-170
Plier Stand
Stainless Steel.



TW5-171
Plier Stand
Stainless Steel.



TW5-172
Plier Stand
Stainless Steel.



TW5-173
Plier Stand
Plastic

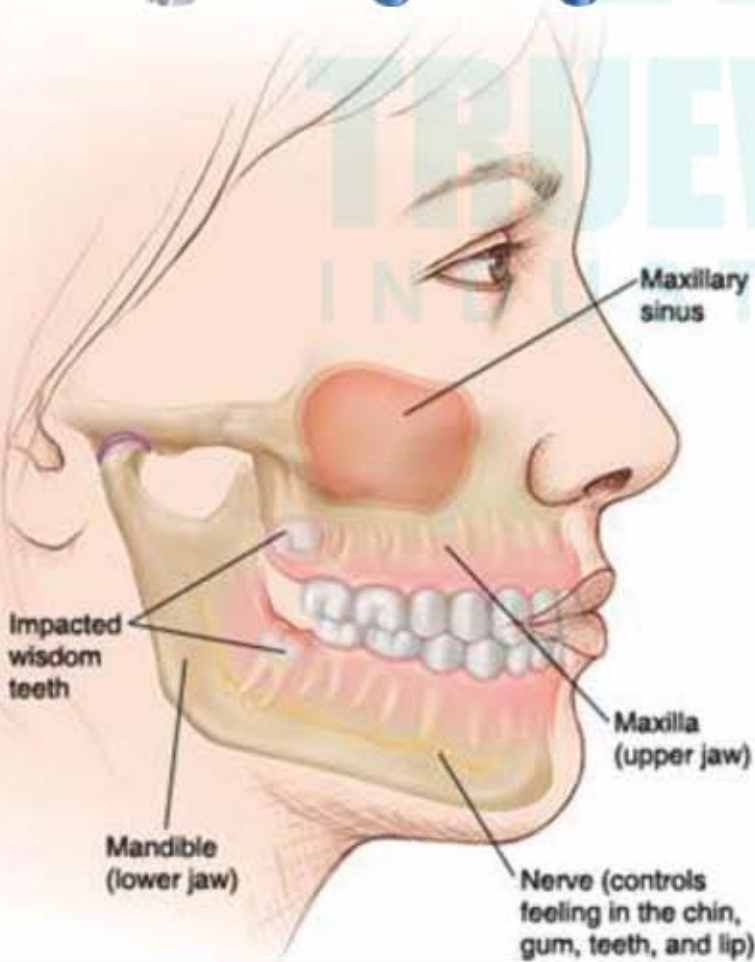

Truewin Instruments for dental implants are made of high quality stainless steel.

Our line of instruments include, but is not limited to, the following products:

Bone Grafting Instruments

- Bone Curettes (SPRATT) – designed for harvesting bone
- Bone Grinder – used in conjunction with a mallet to grind bone into appropriate particle sizes
- Bone Basin – weighted bottom design prevents tipping or spilling while mixing bone or other bone grafting materials

Bone Compactors – feature serrated tips for compacting bone

Scalpels & Biopsy Punches

- Scalpels – offers convenience of a disposable with razor sharp cutting edge for superior cutting
- Biopsy Punches – designed at a steeper angle to ensure a finely honed, sharper edge
- Bone Spreading Chisels
- Freer Chisels – double or single cut tips used for widening ridges during implant preparations

- Graduated Chisels – feature reference markings for measurement during a bone ridge augmentation and are available in straight and curved patterns

Osteotomes

- Concave Osteotomes – break the floor of the maxillary sinus through the implant cavity and are available in curved (off set) and straight (with or without stops)
- Convex Osteotomes – raise the floor of the maxillary sinus and are available in curved (off set) and straight patterns (with or without stops)
- Progressive Osteotomes – designed to prepare the implant site in the maxillary area where bone density is 3 or 4
- Bone Spreading Osteotomes – sharp or blunt configurations for progressive circumferential expansion of the implant site

Sinus Lift Instruments

- Sinus Lift Curettes and Elevators – lightweight, wide diameter stainless steel hand instruments lift the sinus membrane for bone augmentation procedures

Gauges & Calipers

- Gauges & Calipers – various measuring devices available to determine appropriate length, width, and distance for implant procedures

Collagen Products

- Collagen wound dressing product offering includes products.

Sterilization Trays

- Sterilization Trays – designed to protect and store instruments during sterilization, transportation and storage

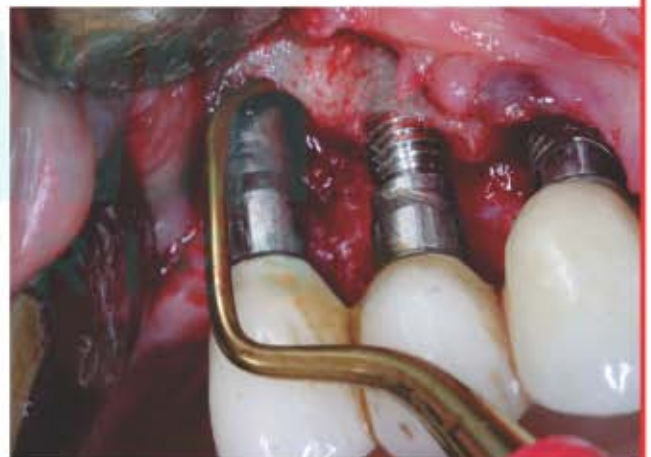

- Инструменты для имплантологии
 - Implantologie
 - Implantologie
- Инструменти для имплантології
 - Implantologia
 - زراعة الأسنان

IMPLANT GAGES



IMPLANT GAGES



- Инструменты для имплантологии
 - Implantologie
 - Implantologie
- Инструменти для имплантології
 - Implantologia
 - زراعة الأسنان



TW6-12
Clamp, Osteometer
Length about 155 mm,
ridge width measurement,
two-sided scale,
measuring
range 0 - 25 mm



TW6-13
Measuring Loop
straight length 90 mm,
measuring range
0 - 40 mm,



TW6-14
Measuring Loop
angled, length 90 mm,
measuring range
0 - 40 mm,



TW6-15
Measuring loop, Castroviejo
angled, length 175 mm,
measuring range 0 - 40 mm,
with window



TW6-16
Boley Gauge
Stainless Steel

TRUEWIN
INDUSTRIES



TW6-17
Measuring Loop
angled, length
175 mm,
measuring range
0 - 40 mm,



TW6-18
Measuring Loop
straight length
175 mm,
measuring range
0 - 40 mm,



TW6-19
Fig. 1
Iwanson
spring caliper
For metal and
porcelain.



TW6-20
Fig. 2
Iwanson
spring caliper
For wax.



TW6-21
Bone Thickness Gauge
40mm, 180mm



TW6-22
Gauge
for measuring
distances
(0 - 90 mm),

- Инструменты для имплантологии
 - Implantologie
 - Implantologie
- Инструменти для имплантології
 - Implantologia
 - زراعة الأسنان

**Hollow Handles 9.5mm Length 170mm
BLACK TITANIUM COLOUR COATED INSTRUMENTS**

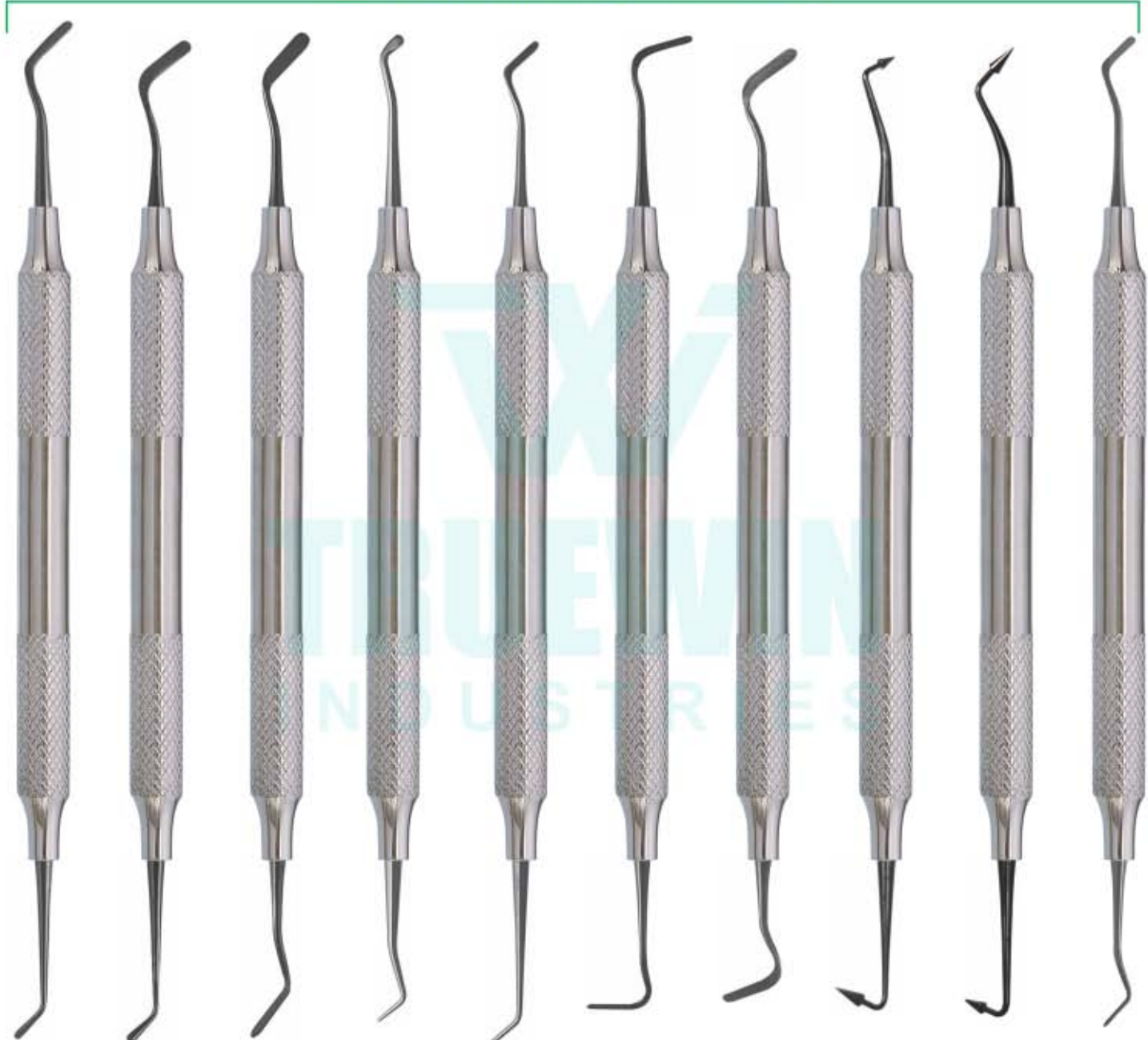

TW6-23
Fig. 1

TW6-24
Fig. 2

TW6-25
Fig. 3
Extra-Flex

TW6-26
Micro-Mini

TW6-27
Mini 1

TW6-28
Mini 4
Extra-Flex

TW6-29
Fig. 4
Extra-Flex

TW6-30
Fig. 5
Flexi-Thin

TW6-31
Fig. 6
Flexi-Thin

TW6-32
Mini 3
Extra-Flex

- Инструменты для имплантологии
 - Implantologie
 - Implantologie
- Инструменти для имплантології
 - Implantologia
 - زراعة الأسنان

Hollow Handles 9.5mm Length 170mm
BLACK TITANIUM COLOUR COATED INSTRUMENTS



TW6-33
AB1
Boghosian

TW6-34
AB2
Boghosian

TW6-35
W3

TW6-36
8A

TW6-37
4/5
Gregg

TW6-38
Interproximal
Carver

TW6-39
Interproximal
Carver, Long

TW6-40
A6

TW6-41
Contouring
instrument

- Инструменты для имплантологии
 - Implantologie
 - Implantologie
- Инструменти для имплантології
 - Implantologia
 - زراعة الأسنان

Hollow Handles 9.5mm Length 170mm
BLACK TITANIUM COLOUR COATED INSTRUMENTS

BURNISHERS

FREEDMAN BURNISHERS



TW6-42
21B

TW6-43
27/29

TW6-44
2
Ladmore

TW6-45
3
Ladmore

TW6-46
Freedman
"Duckhead"

TW6-47
Freedman
Small Contact
Forming

TW6-48
Freedman
Large Contact
Forming

TW6-49
Small/
Medium Ball
Burnisher

- Инструменты для имплантологии
 - Implantologie
 - Implantologie
- Инструменти для имплантології
 - Implantologia
 - زراعة الأسنان

Hollow Handles 9.5mm Length 170mm
BLACK TITANIUM COLOUR COATED INSTRUMENTS

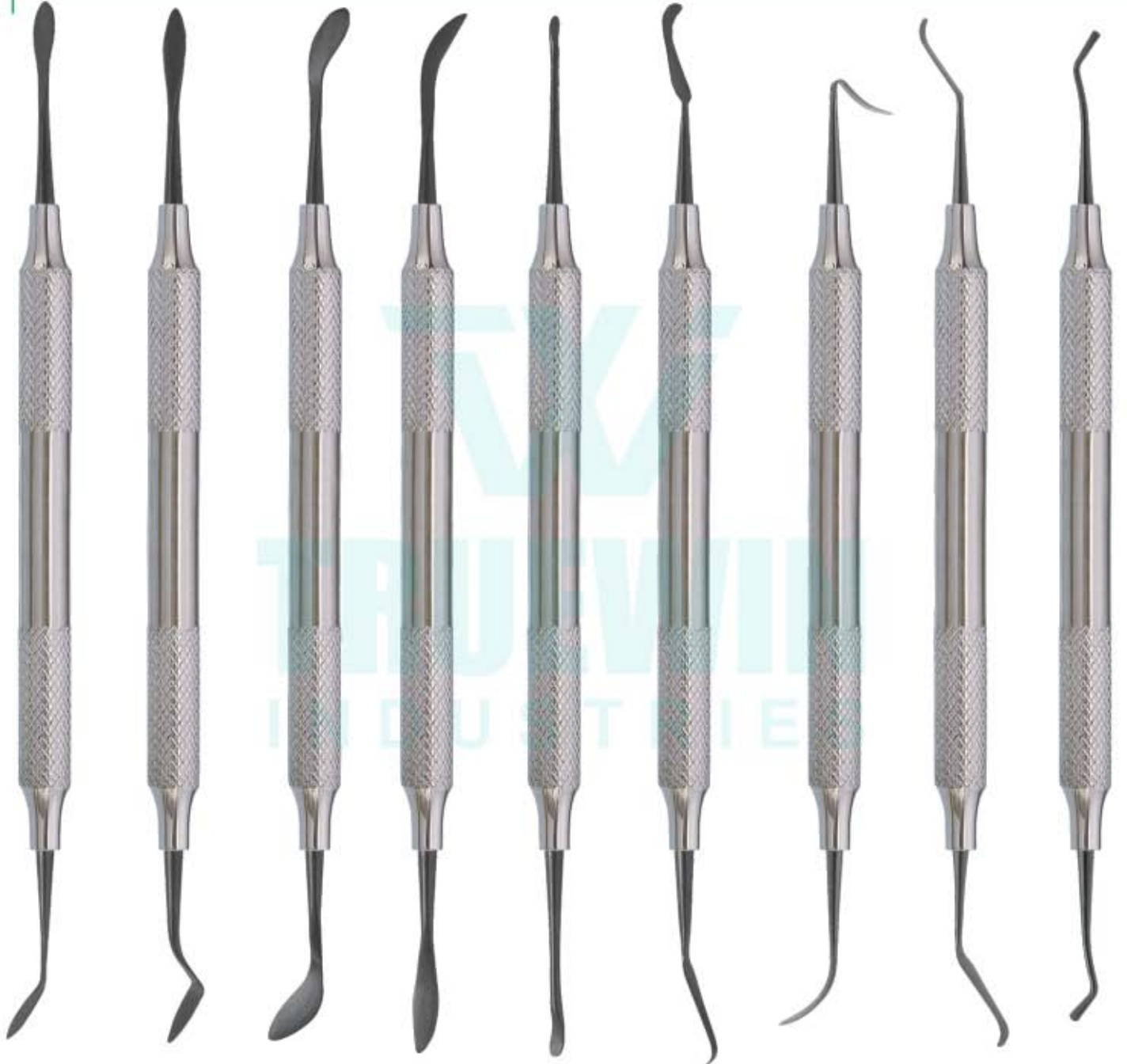

TW6-50
A
Cosmetic
Contouring

TW6-51
B
Cosmetic
Contouring

TW6-52
C
Cosmetic
Contouring

TW6-53
D
Cosmetic
Contouring

TW6-54
E
Cosmetic
Contouring

TW6-55
F
Cosmetic
Contouring

TW6-56
Marginal Ridge
& Embrasure
Shaping Instrument

TW6-57
Occlusal
Anatomy
Instrument

TW6-58
Composite
Packing
Instrument

- Инструменты для имплантологии
 - Implantologie
 - Implantologie
- Инструменти для имплантології
 - Implantologia
 - زراعة الأسنان

**Hollow Handles 9.5mm Length 170mm
BLACK TITANIUM COLOUR COATED INSTRUMENTS**

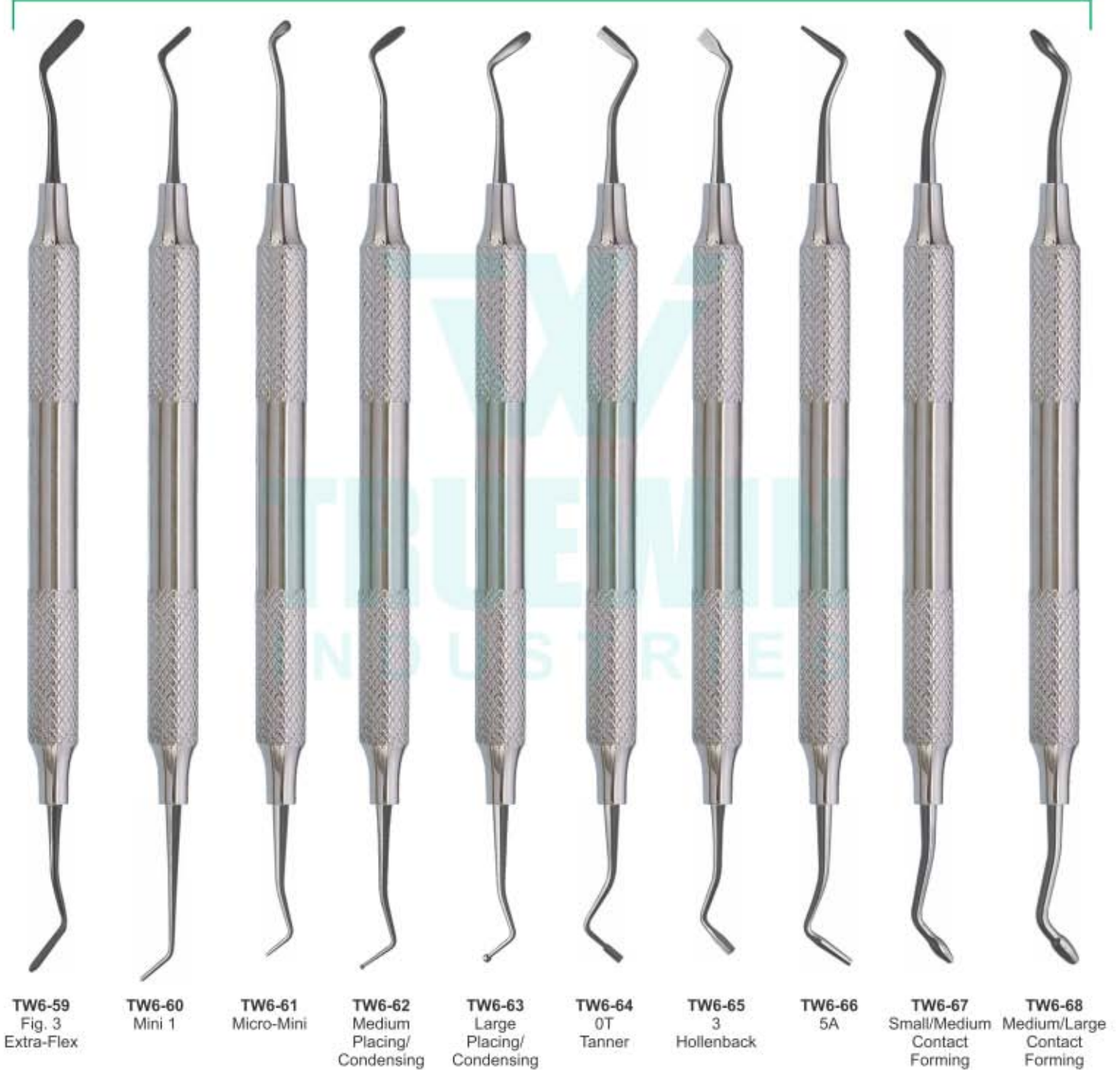

- Инструменты для имплантологии
 - Implantologie
 - Implantologie
- Instrumenti для имплантології
 - Implantologia
 - زراعة الأسنان

**TITANIUM PLASMA COLOUR COATED
SINUS LIFT INSTRUMENTS HOLLOW HANDLE 9.5MM LENGTH 170MM**

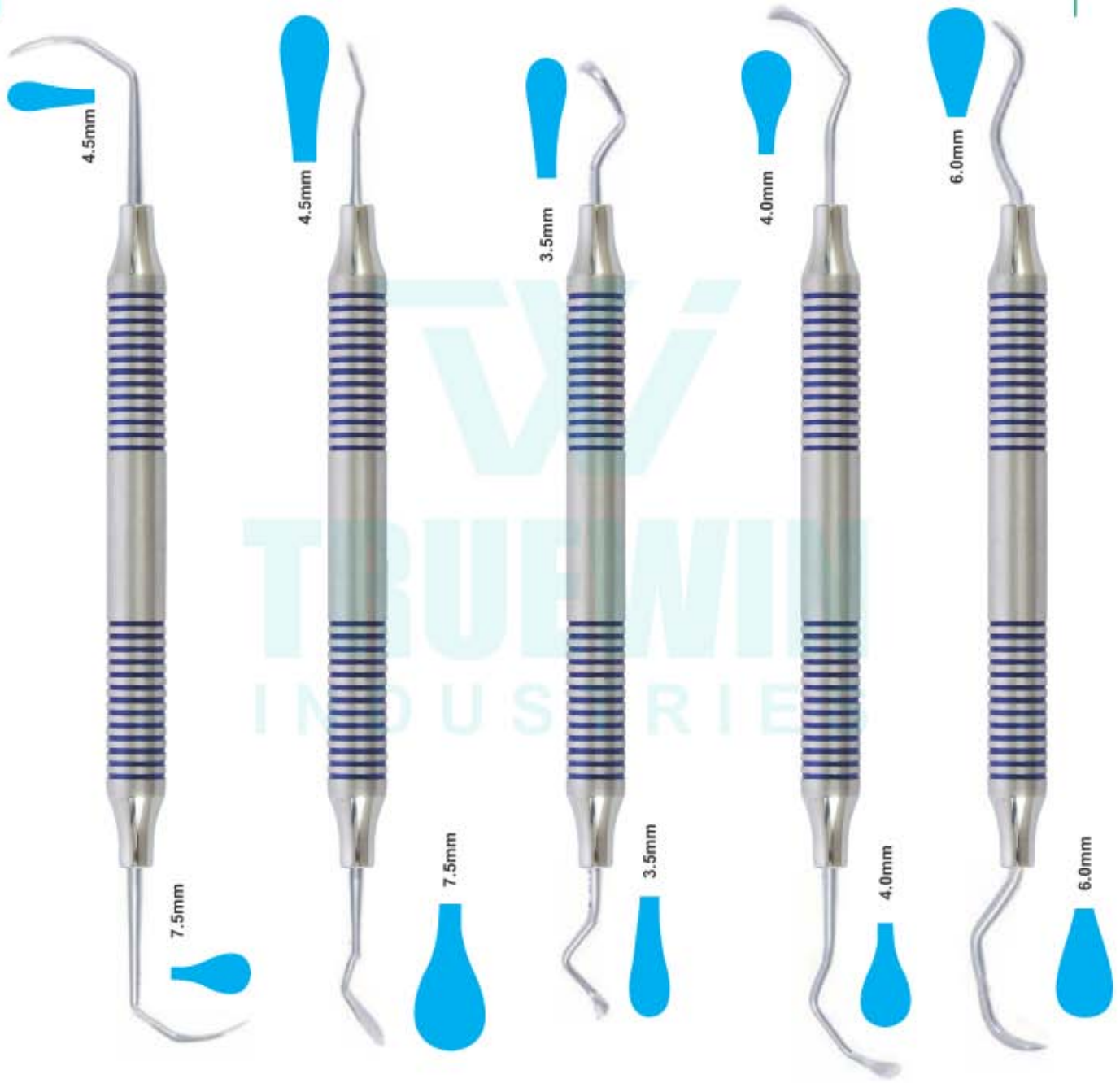

TW6-69
Sinus Lift Elevator

TW6-70
Sinus Lift Elevator

TW6-71
Sinus Lift Elevator

TW6-72
Sinus Lift Elevator

TW6-73
Sinus Lift Elevator

- Инструменты для имплантологии
 - Implantologie
 - Implantologie
- Инструменти для имплантології
 - Implantologia
 - زراعة الأسنان

**TITANIUM PLASMA COLOUR COATED
SINUS LIFT INSTRUMENTS HOLLOW HANDLE 9.5MM LENGTH 170MM**



- Инструменты для имплантологии
 - Implantologie
 - Implantologie
- Инструменти для имплантології
 - Implantologia
 - زراعة الأسنان

**TITANIUM PLASMA COLOUR COATED
IMPLANT SINUS LIFT INSTRUMENTS HOLLOW HANDLE 9.5MM LENGTH 170MM**

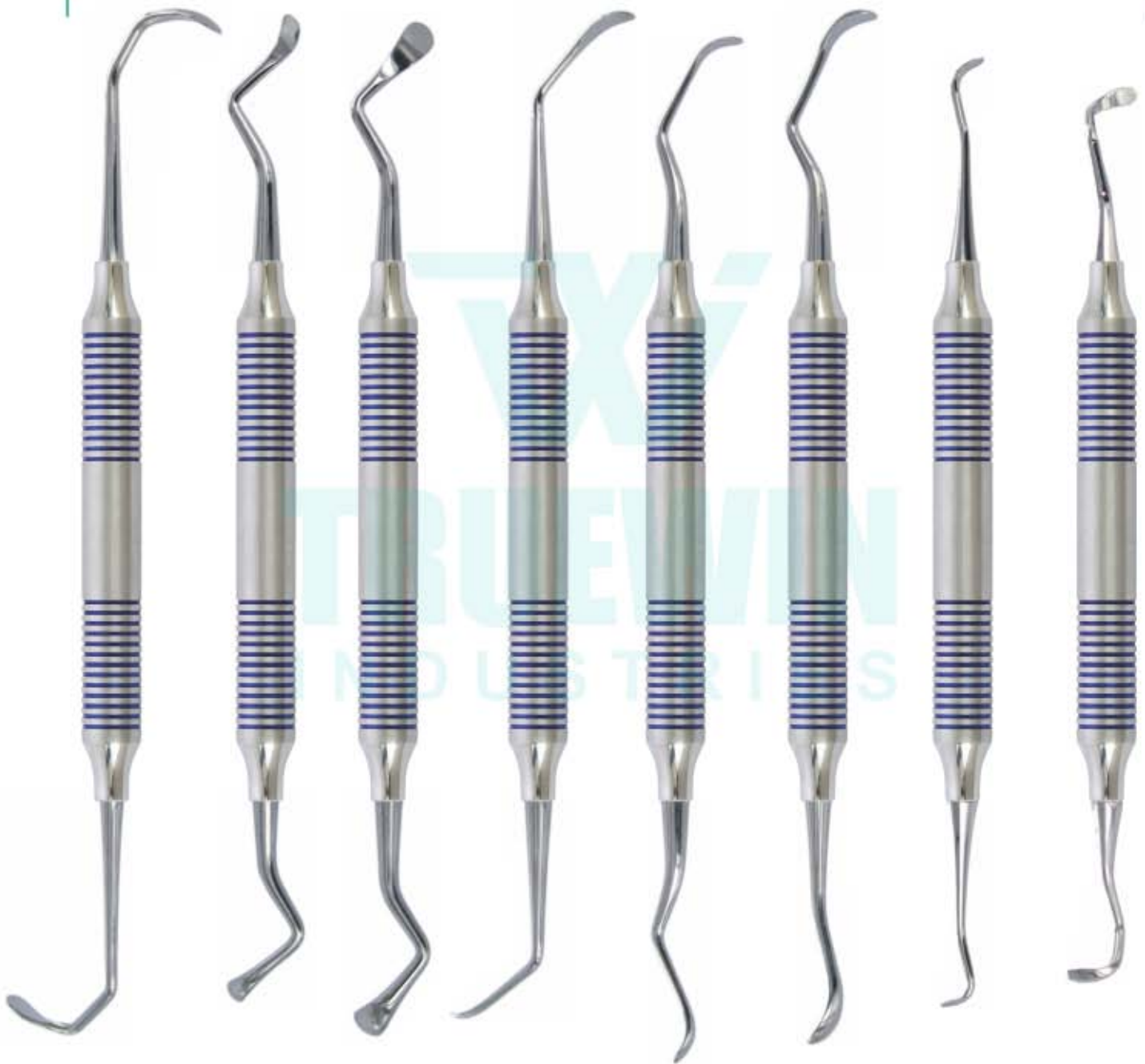

TW6-78
Acute 6577

TW6-79
Sinus1

TW6-80
Sinus2

TW6-81
Sinus3

TW6-82
Sinus4

TW6-83
Sinus5

TW6-84
Sinus6

TW6-85
Sinus7

- Инструменты для имплантологии
- Implantologie
- Implantologie
- Инструменти для имплантології
- Implantologia
- زراعة الأسنان

**TITANIUM PLASMA COLOUR COATED
SINUS LIFT INSTRUMENTS HOLLOW HANDLE 9.5MM LENGTH 170MM**

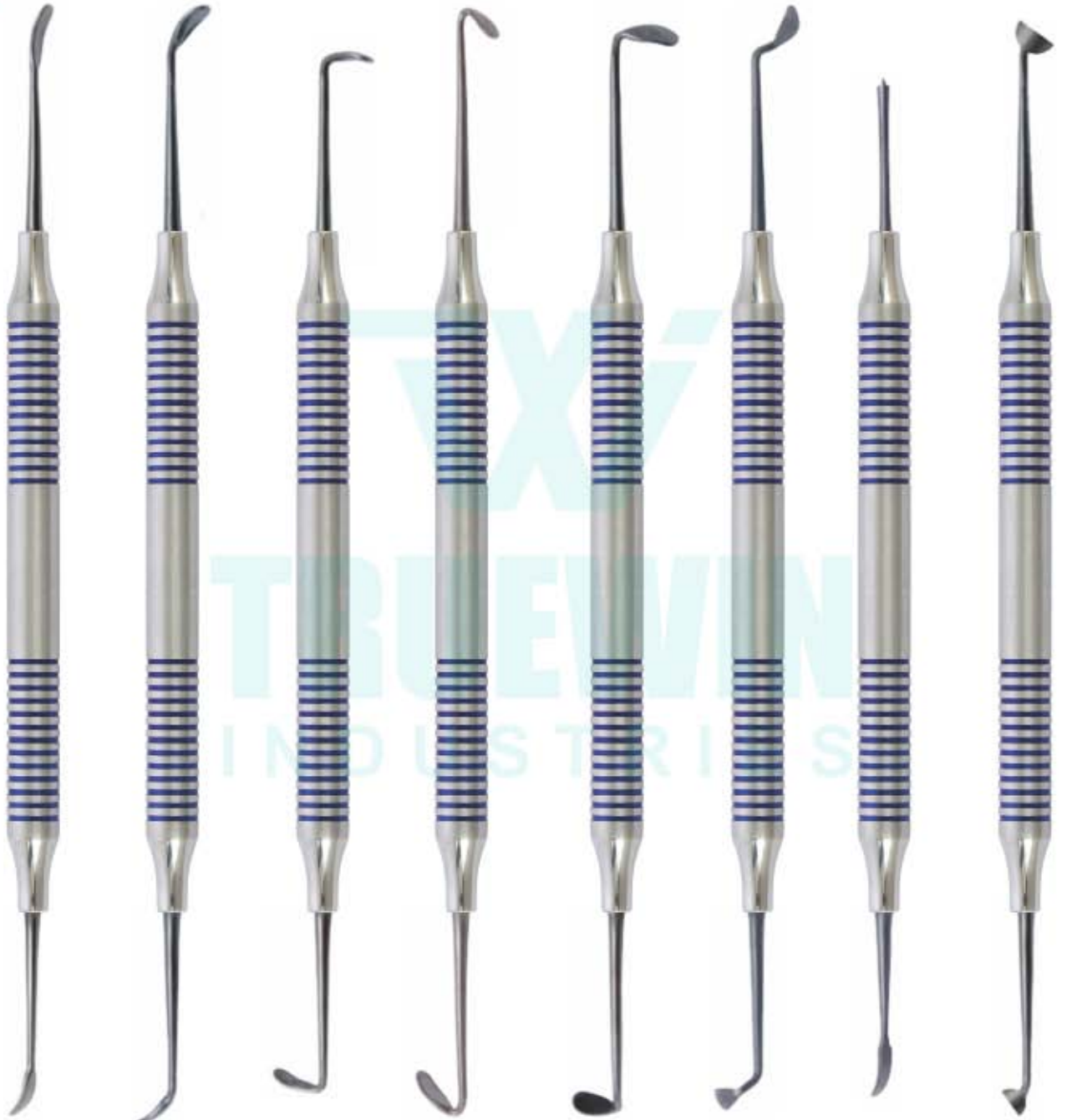

TW6-86
Sinuslift 1

TW6-87
Sinuslift 2

TW6-88
Sinuslift 3

TW6-89
Sinuslift 4

TW6-90
Sinuslift 5

TW6-91
Sinuslift 6

TW6-92
Membrane
3Positioning 1

TW6-93
Condenser 1

- Инструменты для имплантологии
 - Implantologie
 - Implantologie
- Инструменти для имплантології
 - Implantologia
 - زراعة الأسنان

TITANIUM PLASMA COLOUR COATED INSTRUMENTS

Sinus Lift Instrument,
Flexible Sinus Lift instruments
reduce the risk of perforation of the
"Schneider's membrane"

Sinus Lift Elevator,
9.5mm Straight grip
Length 175 mm, Sinus lift elevators, dull,
for gentle peeling and lifting the
Schneider membrane

Sinus lift instrument
9.5mm Straight grip Length 180 mm,
Buser (B1, B2, B3) raspatories,
quality medical stainless steel,
corrosion-resistant

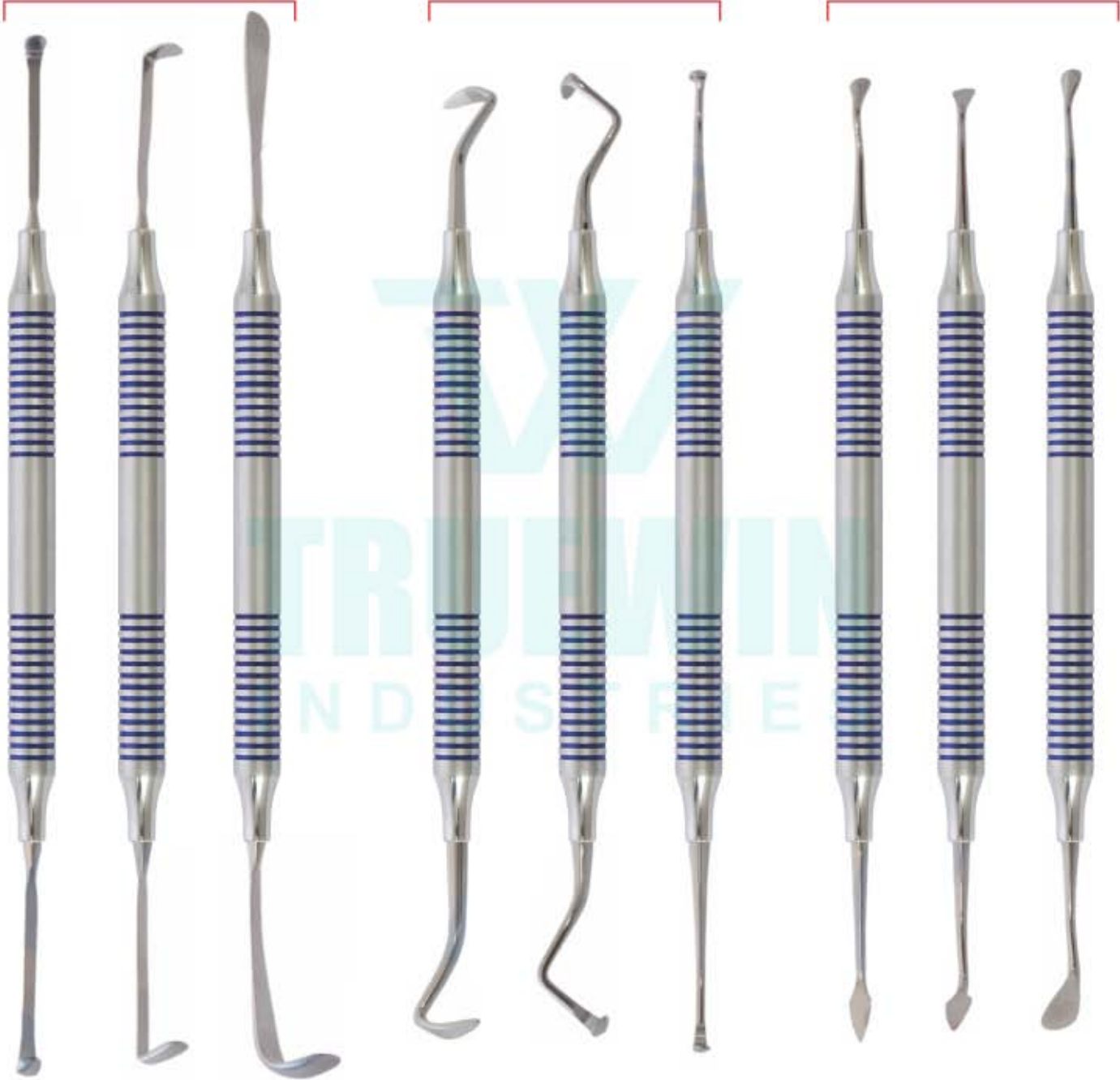

TW6-94
Fig. 1

TW6-95
Fig. 2

TW6-96
Fig. 3

TW6-97
Fig. 1

TW6-98
Fig. 2

TW6-99
Fig. 3

TW6-100
B01

TW6-101
B02

TW6-102
B03

- Инструменты для имплантологии
 - Implantologie
 - Implantologie
- Инструменти для имплантології
 - Implantologia
 - زراعة الأسنان

TITANIUM PLASMA COLOUR COATED INSTRUMENTS

Sinus lift instrument 9.5mm Straight grip Sinus lift elevators, blunt or sharply curved (H01, H02, K03, K04, K78, K77)



TW6-103
Sinus lift instrument
H01

TW6-104
Sinus lift instrument
H02

TW6-105
Sinus lift instrument
K03

TW6-106
Sinus lift instrument
K04

TW6-107
Sinus lift instrument
K78

TW6-108
Sinus lift instrument
K77

- Инструменты для имплантологии
- Implantologie
- Implantologie
- Инструменти для имплантології
- Implantologia
- زراعة الأسنان

TITANIUM PLASMA COLOUR COATED INSTRUMENTS

SINUS LIFT INSTRUMENT

Sinus Lift Elevators, 9.5mm Hollow Handle length 170mm Blunt Curved Set of 6 Pcs

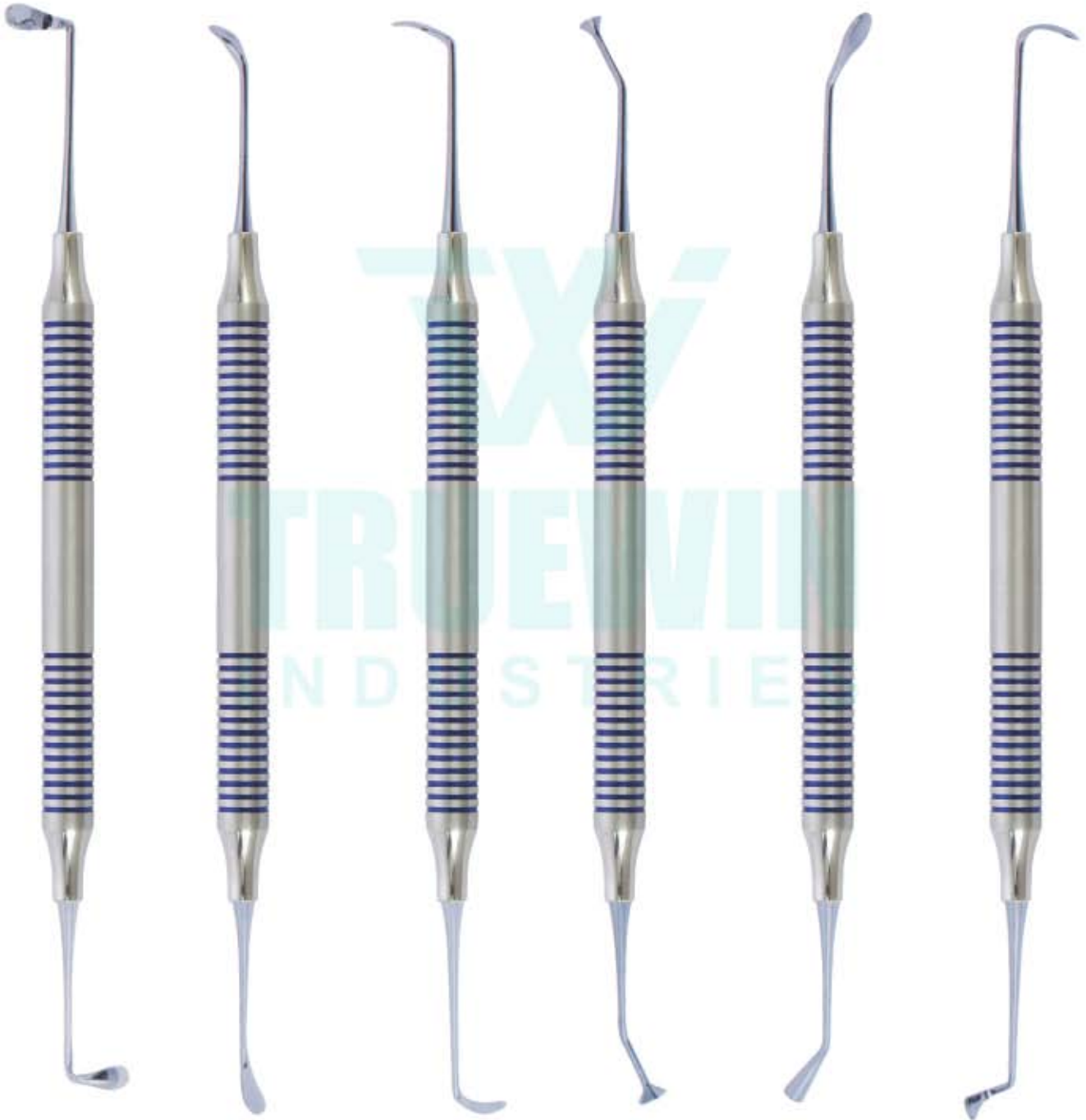

TW6-109

TW6-110

TW6-111

TW6-112

TW6-113

TW6-114

- Инструменты для имплантологии
- Implantologie
- Implantologie
- Инструменти для имплантології
- Implantologia
- زراعة الأسنان

Hollow Handle 9.5mm Length 170mm
PERIODONTAL SURGERY SURGICAL CHISELS
KRAMER NEVINS SINUS LIFT

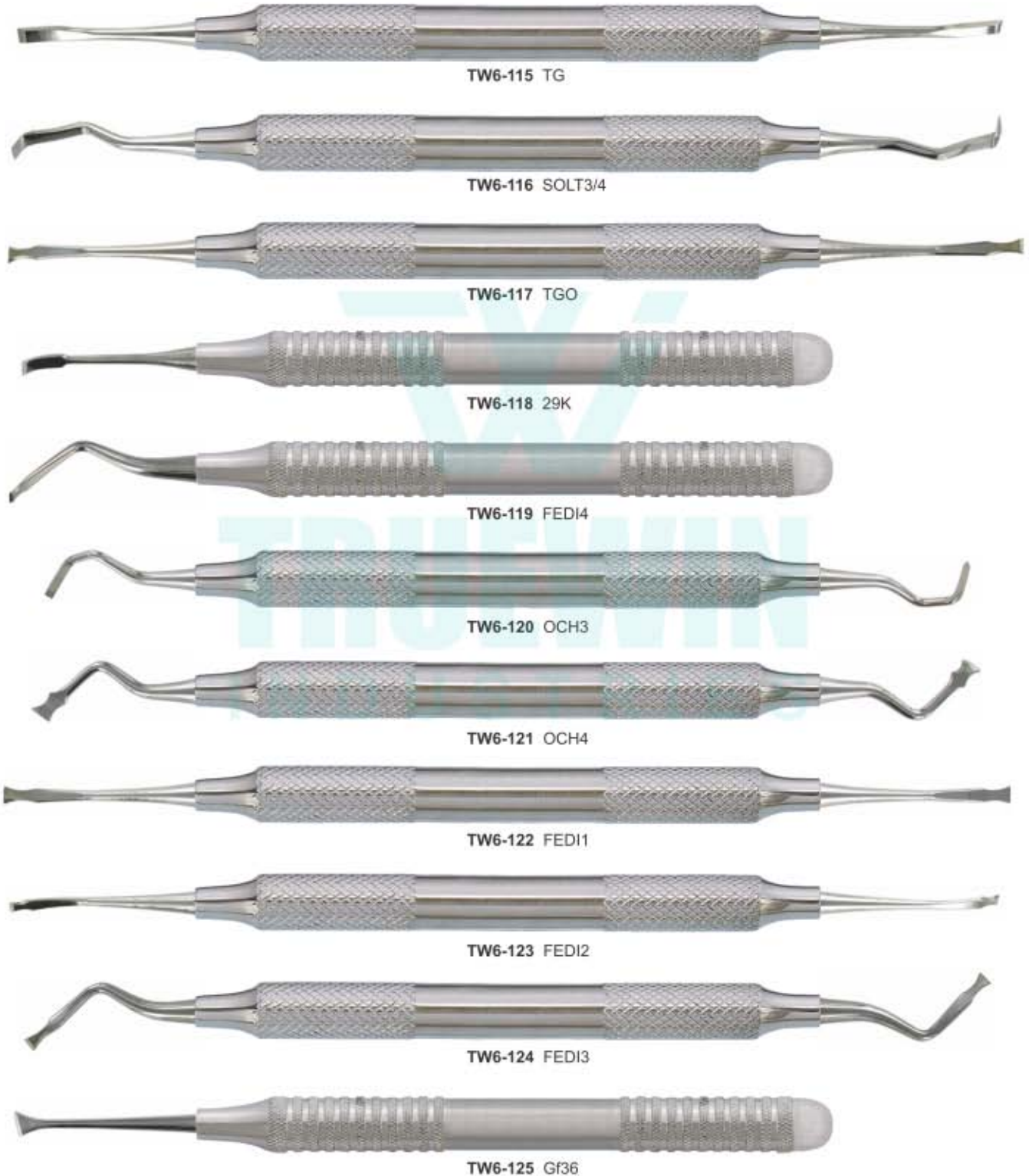

- Инструменты для имплантологии
 - Implantologie
 - Implantologie
- Инструменти для імплантології
 - Implantologia
 - زراعة الأسنان

**Hollow Handle 9.5mm Length 170mm
IMPLANT SURGICAL CHISELS**



TW6-126 13K/TG



TW6-127 13K/TG Titanium Plasma Coated Point



TW6-128 13K/TG



TW6-129 13KL/R Titanium Plasma Coated Point



TW6-130 13KL 4/6mm



**TW6-131 Pt2 Titanium Plasma Coated Point
A/V Regular**



**TW6-132 Pt1 Titanium Plasma Coated Point
A/V Regular**



TW6-133 Pt3 Titanium Plasma Coated Point Angel S/E



TW6-134 Pt4 Titanium Plasma Coated Point STR S/E



TW6-135 Pt5 Titanium Plasma Coated Point TG CVD S/E

- Инструменты для имплантологии
 - Implantologie
 - Implantologie
- Instrumenti для имплантології
 - Implantoloia
 - زراعة الأسنان

TITANIUM PLASMA COLOUR COATED INSTRUMENTS
Hollow Handle 10mm
MIXING SPATULA WITH SHOVEL



TW6-136
 Bone Carrier
 Titanium
 185mm



TW6-137
 Raspator, Prichard
 Length 180 mm,
 10 mm hollow handle,
 double-ended
 10.5 mm | 4.5 mm



TW6-138
 Raspator, Prichard
 Length 180 mm,
 10 mm hollow handle,
 double ended



TW6-139
 Raspator, Prichard
 Length 180 mm,
 10 mm hollow handle,
 double-ended
 10.5 mm | 4.5 mm



TW6-140
 Mixing Spatula
 with shovel
 170mm



TW6-141
 Mixing Spatula
 with shovel
 185mm

- Инструменты для имплантологии
 - Implantologie
 - Implantologie
- Инструменти для имплантології
 - Implantologia
 - زراعة الأسنان

BONE GRAFTING INSTRUMENTS COMPACTOR /TAMPERS

Product offering includes instruments for harvesting, mixing and compacting bone Provides clinicians with the proper instrumentation for bone grafting procedures Weighted bone basin Prevents tipping and spilling of bone and other materials during mixing

Hollow Handle 9.5mm Length 170mm



TW6-142
Graft Packer,
Concave Tips
DE 4/6mm

TW6-143
Bone Spoon/
Packer DE 3mm

TW6-144
Graft Packer,
Serrated Tips
DE 6/8mm

TW6-145
Graft Packer,
Serrated Tips
DE 3/4mm

TW6-146
Graft Packer,
Smooth Tips
DE 5/8mm

TW6-147
Titanium graft packer/
placement site depth
gauge 3.3mm & 4.0mm
Diameter tips Marked
at 8, 11, 13, 15 & 18mm

TW6-148
Graft Material Spoon
Concave Tip For
Larger Grafts

- Инструменты для имплантологии
 - Implantologie
 - Implantologie
- Инструменти для имплантології
 - Implantologia
 - زراعة الأسنان

BONE GRAFTING INSTRUMENTS
TITANIUM PLASMA COLOUR COATED
Hollow Handle 9.5mm



TW6-149
 Blade and pusher
 Length 180 mm,
 for straight or angled,
 blade: 15 x 5 mm,
 pusher: 4 mm diameter
 Straight



TW6-150
 Blade and pusher
 Length 180 mm,
 for straight or angled,
 blade: 15 x 5 mm,
 pusher: 4 mm diameter
 angular



TW6-151
 Spoon and pusher
 Length 180 mm,
 for angled spoon:
 10 x 5 mm, pusher:
 diameter 3 mm



TW6-152
 Tunnelierungs
 Instrument
 length 175 mm,



TW6-153
 Tunnelierungs
 Instrument
 length 175 mm,
 different designs



TW6-154
 Tamper
 Length 170 mm,
 for bone material,
 double-ended,
 diameter 3.2 mm
 (2-4-6-8-10) and diameter
 2.5mm (2-4-6-8-10)

- Инструменты для имплантологии
 - Implantologie
 - Implantologie
- Инструменти для имплантології
 - Implantologia
 - زراعة الأسنان

Pluggers

Hollow Handle 9.5mm Length 160 mm, with titanium tips for mixing and pouring of autologous, heterologous bone substitute material, diameter (3/4 or 6/8 mm)

BONE GRAFTING INSTRUMENTS



TW6-155 Ø 4mm
TW6-156 Ø 5mm
Compactor
150mm



TW6-157
Sinus Window
Bone Tampers
4 mm



TW6-158
Sinus Window
Bone Tampers
7 mm



TW6-159
6/8mm



TW6-160
3/4mm

- Инструменты для имплантологии
 - Implantologie
 - Implantologie
- Инструменти для имплантології
 - Implantologia
 - زراعة الأسنان

SPOON AND PUSHER (TRINOVO)

Hollow Handle 9.5mm Length 180mm

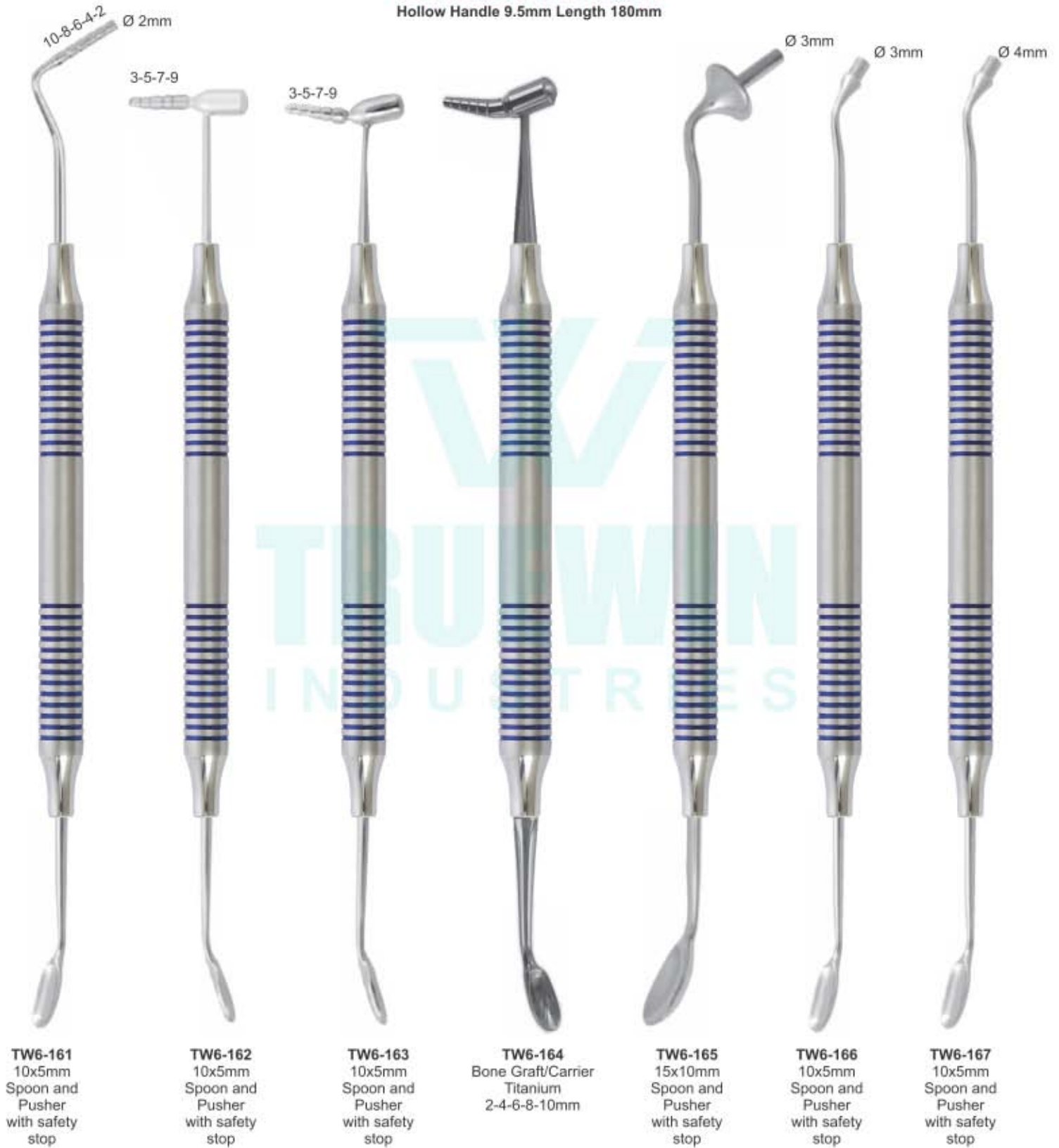

TW6-161
10x5mm
Spoon and
Pusher
with safety
stop

TW6-162
10x5mm
Spoon and
Pusher
with safety
stop

TW6-163
10x5mm
Spoon and
Pusher
with safety
stop

TW6-164
Bone Graft/Carrier
Titanium
2-4-6-8-10mm

TW6-165
15x10mm
Spoon and
Pusher
with safety
stop

TW6-166
10x5mm
Spoon and
Pusher
with safety
stop

TW6-167
10x5mm
Spoon and
Pusher
with safety
stop

- Инструменты для имплантологии
 - Implantologie
 - Implantologie
- Инструменти для имплантології
 - Implantologia
 - زراعة الأسنان

PERIOSTEALS ELEVATOR 10mm Hollow Handle



TW6-168
Raspator,
Bone Scraper
Length 165 mm,
10 mm hollow
handle,
double-ended 6
mm / 4 mm,

TW6-169
Raspator,
Raspatory
Length 180 mm,
10 mm hollow
handle,
double-ended
3 mm | 3 mm,

TW6-170
Raspator,
Raspatory
Length 180 mm,
10 mm hollow
handle,
double-ended
3 mm | 3 mm,

TW6-171
Raspator,
Papilla
Length 185 mm,
10 mm hollow
handle,
double-ended
3 mm | 2 mm,

TW6-172
Raspator,
Bone Scraper
Length 175 mm,
10 mm hollow
handle,
double-ended,

TW6-173
Raspator,
Micro-Freer
Length 180 mm,
10 mm hollow
double-ended
3 mm | 4 mm

TW6-174
Raspator,
Freer
Length 180 mm,
10 mm hollow
handle,
double-ended
5 mm | 5 mm,

- Инструменты для имплантологии
 - Implantologie
 - Implantologie
- Инструменти для имплантології
 - Implantologia
 - زراعة الأسنان

PERIOSTEALS ELEVATOR 10mm Hollow Handle



TW6-175
Raspator,
Freer
10 mm hollow
handle,
high-quality
medical
double ended

TW6-176
Raspator,
Molt
Length 180 mm,
10 mm Hollow
grip,
double-ended
6 mm

TW6-177
Raspator,
Micro Freer
Length 185 mm,
10 mm hollow
handle,
double-ended

TW6-178
Raspator,
Micro Freer
Length 185 mm,
10 mm hollow
handle,
double-ended

TW6-179
Raspator, Micro
Raspator /
Chisel
Length 170 mm,
10 mm hollow
handle,
double-ended

TW6-180
Raspator, Micro
Raspator /
Chisel
Length 175 mm,
10 mm hollow
handle,
double-ended

TW6-181
Raspator,
Micro Raspator /
Chisel
Length 175 mm,
10 mm hollow handle,
double-ended
3.5mm | 3.5 mm

- Инструменты для имплантологии
 - Implantologie
 - Implantologie
- Инструменти для имплантології
 - Implantologia
 - زراعة الأسنان

PERIOSTEALS ELEVATOR 10mm Hollow Handle



TW6-182
Raspatory Micro Molt
Length 175 mm,
corrosion-resistant

TW6-183
Raspatory Chipping
Workers:
Chisel 24G and 7.5 mm,
length about 175 mm,
corrosion-resistant

TW6-184
Raspatory Molt
Work ends:
5.0 mm and 4.0 mm,
length about 175 mm,
corrosion-resistant

TW6-185
Rasp, Molt M9
Length 175 mm,
corrosion-resistant

TW6-186
Raspator, Wautier
Length 175 mm,
corrosion-resistant

TW6-187
Raspator, Benque
Length 170 mm,
workers
5 mm | 7 mm,
corrosion-resistant

TW6-188
Raspator, Nordberg
Length 180 mm,
10 mm hollow handle,
double-ended
6 mm | 4 mm

- Инструменты для имплантологии
- Implantologie
- Implantologie
- Инструменти для имплантології
- Implantologia
- زراعة الأسنان

Curettes Hollow Handle 10mm Length 170mm

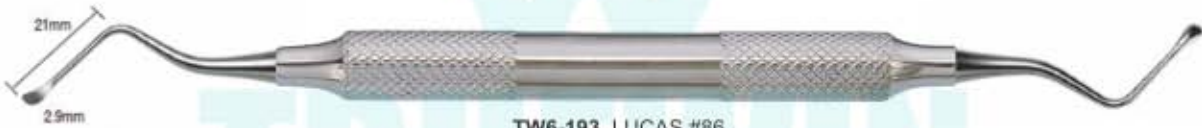

- Инструменты для имплантологии
 - Implantologie
 - Implantologie
- Инструменти для имплантології
 - Implantologia
 - زراعة الأسنان

TISSUE MEMBRANE FORCEPS



TW6-198
Tissue Graft Forcep
Serrated Teeth
150mm



TW6-199
Self Locking
Grooved
150mm



TW6-200
Tissue Graft Forcep
Serrated Teeth
150mm



TW6-201
Titanium Metal
Locking Plier



TW6-202
TC Gripper Carbide
Tipped Tissue Forceps
Serrated Carbide Tips
145mm



TW6-203
Adson Carbide
Tipped Tissue Forceps
Serrated Carbide Tips
120mm



TW6-204
Micor Adson
Tissue Forcep 120mm
1x2 Teeth - 0.5mm Tips



TW6-205
Adson 7x7
Tissue Forceps
7x7 Teeth 120mm



TW6-206
Adson 7x7 Curved
Tissue Forceps
7x7 Teeth 120mm



TW6-207
Suture Pliers
Suture Forceps with
1.6mm Ring Tip
160mm



TW6-208
Debaquey Atraumatic
Tissue Forceps Straight
Serrated Teeth
160mm



TW6-209
Debaquey Atraumatic
Tissue Forceps Curved
Serrated Teeth
160mm

- Инструменты для имплантологии
 - Implantologie
 - Implantologie
- Инструменти для имплантології
 - Implantologia
 - زراعة الأسنان

TISSUE MEMBRANE FORCEPS



TW6-210
Russian Long
Tissue Forceps
Serrated Tip
200mm



TW6-211
Russian
Tissue Forceps
Serrated Tip
150mm



TW6-212
Tissue Punch Forceps
To Remove Tissue
After Using Punch
150mm



TW6-213
narrow
135mm



TW6-214
105mm
Membrane tweezers KUEHNE



TW6-215
wide
135mm



TW6-216
Pin-Tweezers
length 150mm
with lock



TW6-217
without lock
150mm



TW6-218
Haltepinzette with lock
155mm, for pins, towards
the tips, etc



TW6-219
Carry Forceps
150mm



TW6-220
Carry Forceps
150mm



TW6-221
Carry Forceps
150mm

- Инструменты для имплантологии
- Implantologie
- Implantologia
- زراعة الأسنان

OSTEOTOME CONVEXES / CONCAVE / CONIQUES

CONVEXES



TW6-222
SET OF 5 PIECES
Convexes

CONCAVES

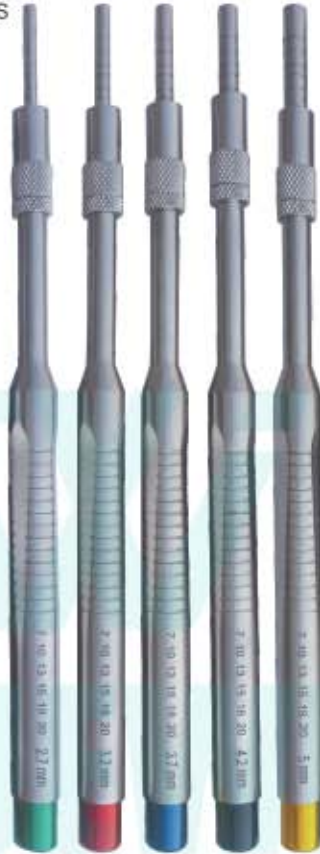

TW6-223
SET OF 5 PIECES
Concaves

CONIQUES



TW6-224
SET OF 5 PIECES
Coniques

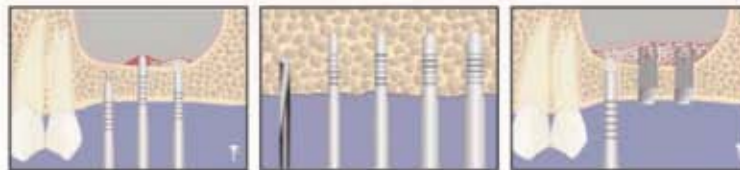

	CONVEXES STRAIGHT	TW6-222	2,7 Ømm	3,2 Ømm	3,7 Ømm	4,2 Ømm	5 Ømm
	CONCAVES STRAIGHT	TW6-223	2,7 Ømm	3,2 Ømm	3,7 Ømm	4,2 Ømm	5 Ømm
	CONIQUES STRAIGHT	TW6-224	2,7 Ømm	3,2 Ømm	3,7 Ømm	4,2 Ømm	5 Ømm

- Инструменты для имплантологии
 - Implantologie
 - Implantologie
- Инструменти для имплантології
 - Implantologia
 - زراعة الأسنان

OSTEOTOME CONVEXES / CONCAVE / CONIQUES



TW6-225
SET OF 5 PIECES
Convexes Curved

TW6-226
SET OF 5 PIECES
Concaves Curved

TW6-227
SET OF 5 PIECES
Coniques Curved

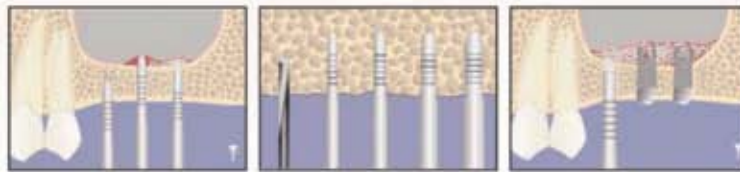

	CONVEXES CURVED	TW6-225	2,7 Ømm	3,2 Ømm	3,7 Ømm	4,2 Ømm	5 Ømm
	CONCAVES CURVED	TW6-226	2,7 Ømm	3,2 Ømm	3,7 Ømm	4,2 Ømm	5 Ømm
	CONIQUES CURVED	TW6-227	2,7 Ømm	3,2 Ømm	3,7 Ømm	4,2 Ømm	5 Ømm

- Инструменты для имплантологии
- Implantologie
- Implantologie

- Инструменти для имплантології
- Implantologia
- زراعة الأسنان

TREPINE

Burs with depth markings are suited for precise and simple transplantation of cylindrical bone grafts as well as for all other bone-extraction tasks.



TW6-237
Tissue Punch with pin
Set of 4 Pcs

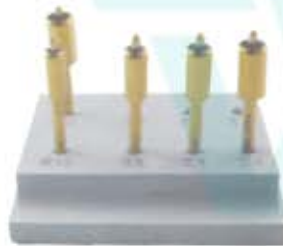

TW6-238
Tissue Punch
Set of 5 Pcs



TW6-239
Tissue Punch
Set of 5 Pcs



TW6-240
Trephine Drill
Set of 8 Pcs

TRUEWIN
INDUSTRIAL



Ø2.0mm Ø2.5mm Ø2.8mm

TW6-241
Short Implant Drills
Set of 3 Pcs

Ø3.2mm Ø3.65mm Ø4.2mm Ø5.2mm

TW6-242
Long Implant Drills
Set of 4 Pcs



TW6-243
Trephine Drill
Set of 8 Pcs

- Инструменты для имплантологии
 - Implantologie
 - Implantologie
- Инструменти для имплантології
 - Implantologia
 - زراعة الأسنان

BONE SCRAPER STRAIGHT & CURVED



TW6-244
Bone Scraper
Straight

TW6-245
Bone Scraper
Curved

TISSUE PUNCH STRAIGHT & CURVED



Tissue Punch
Straight

Tissue Punch
Curved



TW6-258
Bone Mill



TW6-259
Basins For Bone

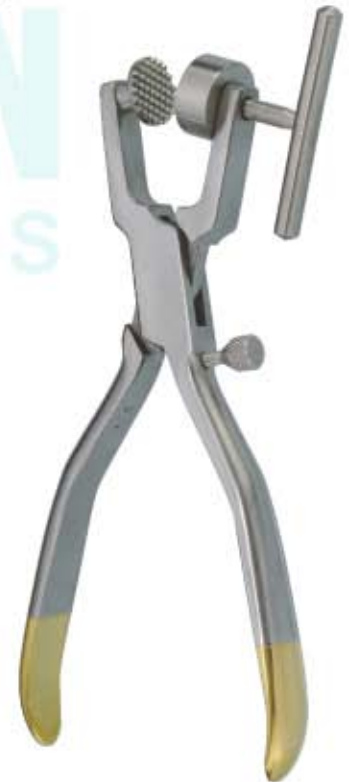

TW6-260
Bone Crusher
Metal With Titanium Crusher

TRUEWIN
INDUSTRIES

- Инструменты для имплантологии
 - Implantologie
 - Implantologie
- Инструменти для имплантології
 - Implantologia
 - زراعة الأسنان

KEYS FOR IMPLANT SCREW



TW6-261



TW6-262



TW6-263



TW6-264

TORQUE WRENCH & RATCHET



TW6-265 Star Torque Wrench 6.35mm Universal



TW6-266 Round Torque Wrench 4.0mm Universal



TW6-267 Hex Driver With 4.0mm Driver



TW6-268 Star Torque Wrench 6.35mm Universal



TW6-269 Hex Torque Wrench 4.00mm Universal



TW6-270 Star Torque Wrench 6.35mm Universal



TW6-271 Star Torque Wrench 6.35mm Universal



TW6-272 Star Torque Wrench 6.35mm Universal



TW6-273 Star Torque Wrench 6.35mm Universal



TW6-274 Star Torque Wrench 6.35mm Universal



TW6-275 Star Ratchet Wrench 6.35mm Universal



TW6-276 Star Ratchet Wrench 6.35mm Universal



TW6-277 Star Ratchet Wrench 6.35mm Universal



TW6-278 Star Ratchet Wrench 4.0mm Universal



TW6-279 Round Ratchet Wrench 4.0mm Universal



TW6-280 Round Ratchet Wrench 3.35mm Universal



TW6-281 Star Ratchet Wrench 4.0mm Universal



TW6-282 Star Ratchet Wrench 6.35mm Universal

- Инструменты для имплантологии
 - Implantologie
 - Implantologie
- Инструменти для имплантології
 - Implantologia
 - زراعة الأسنان

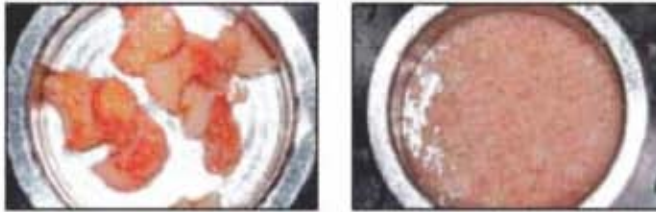

TW6-283
Bone Crusher
Titanium Metal Cutter
Set of 2 Pcs
Bone Crusher + Mallet

mallet



TW6-284
Bone Crusher
Titanium Metal Cutter
Set of 2 Pcs
Bone Crusher + Mallet

mallet



TW6-285
Bone Crusher



TW6-286
Bone Crusher
Bone Grinding Grain
1.5mm, 2mm, 2.5mm



TW6-287
Bone Crusher
Bone Grinding Grain
1.5mm, 2mm, 2.5mm

- Инструменты для имплантологии
 - Implantologie
 - Implantologie
- Инструменти для імплантології
 - Implantologia
 - زراعة الأسنان

BONE EXPANDER SCREW & SURGICAL KITS



TW6-288
 Bone Universal Kit
 Drill: 2mm, 2.8mm, 3.2mm, 3.65mm,
 4.2mm, 4.5mm, 4.8mm, 5.2mm
 Trephines Bit:
 3.0mm, 4.0mm, 5.0mm, 6.0mm,
 7.0mm, 8.0mm, 9.0mm, 10mm.
 Driver:
 2.5mm, 2.5mm Hand Pcs
 1.25mm, 1.25mm Hand Pcs
 Short Driver 2.5mm
 Long Driver 2.5mm
 1.25mm, Short Hex Driver Hand Pcs
 1.25mm, Long Hex Driver Hand Pcs
 Torque Wrench 4.0mm



TW6-289
 Bone Expander Kit
 Expander: 2.6mm, 3.0mm,
 3.4mm, 3.8mm, 4.3mm
 Ratchet Driver
 Parallel Pin
 Pilot Drill
 Drill 1.4mm
 Drill Driver 4mm
 Hand Driver 4mm
 Ratchet 4.0mm



TW6-290
 Bone Universal Kit
 Drill: 2mm, 2.8mm, 3.2mm, 3.65mm,
 4.2mm, 4.5mm, 4.8mm, 5.2mm
 Trephines Bit:
 3.0mm, 4.0mm, 5.0mm, 6.0mm,
 7.0mm, 8.0mm, 9.0mm, 10mm.

Bone Compression:
 2mm, 3.3mm, 2.8mm, 4.2mm, 3mm, 3.5mm
 Driver:
 2.5mm, 2.5mm Hand Pcs
 1.25mm, 1.25mm Hand Pcs
 Short Driver 2.5mm
 Long Driver 2.5mm
 1.25mm, Short Hex Driver Hand Pcs
 1.25mm, Long Hex Driver Hand Pcs
 Torque Wrench 6.35mm 1 Pcs



TW6-291
 Conical Drills: 20 Pcs
 Tissue Punches:
 3.0mm, 3.50mm, 4.0mm, 4.5mm,
 5.0mm, 6.0mm, 6.50mm
 Bone Expander:
 1.6/3.8mm, 1.9/3.0mm, 2.1/3.6mm,
 2.6/3.8mm, 2.9/4.3mm
 Drill Adapter: 1 Pcs
 1.25mm, 2.50mm Hex Driver Hand Pcs

Pilot Drill: 1.6mm
 Drill Bit: 1.4mm, 1.6mm, 1.8mm, 2.0mm, 2.2mm
 Ratchet Driver: 4mm/6.35, 1.25/2.50
 Rimer: 3.2/4.7mm, 3.7/4.7mm
 Parallel Pin: 4.5mm, 2.5mm
 Double step Drill: 2.4/2.8mm
 Depth Gauge: 1 Pcs
 Torque Wrench 6.35mm Universal: 1 Pcs

- Инструменты для имплантологии
 - Implantologie
 - Implantologie
- Инструменти для имплантології
 - Implantologia
 - زراعة الأسنان

BONE INJECTORS, COLLECTORS & SUCTION TUBE



TW6-292 Ø 2,5mm Straight / Bend 180mm I.D 2.5mm O.D 3.5	TW6-293 Ø 3,5mm Straight / Bend 180mm I.D 3.5mm O.D 4.5	TW6-294 Ø 4,5mm Straight / Bend 180mm I.D 4.5mm O.D 5.5	TW6-295 Ø 6,0mm Straight / Bend 180mm I.D 6.0mm O.D 7.0	TW6-296 Ø 2,5mm 170mm I.D 2.5mm O.D 3.5	TW6-297 Ø 3,5mm 170mm I.D 3.5mm O.D 4.5	TW6-298 Ø 4,5mm 170mm I.D 4.5mm O.D 5.5	TW6-299 Ø 6,0mm 170mm I.D 6.0mm O.D 7.0
---	---	---	---	--	--	--	--



TW6-300 175mm Ø 20mm	TW6-301 180mm Ø 27mm	TW6-302 coarse Ø 5mm	TW6-303 fine Ø 9mm Suction tubes to collect the extracted bone material 180mm	TW6-304 Suction Tubes 180mm	TW6-305 Suction Tubes 180mm	TW6-306 Suction Tubes 180mm	TW6-307 Fig. 6FR Frazier 150mm - Ø 2 mm	TW6-308 Ø 3 mm length 180mm	TW6-309 Ø 4 mm length 180mm	TW6-310 Ø 5 mm length 180mm
-----------------------------------	-----------------------------------	-----------------------------------	---	--	--	--	---	--	--	--

- Инструменты для имплантологии
 - Implantologie
 - Implantologie
- Инструменти для імплантології
 - Implantologia
 - زراعة الأسنان



TW6-311
Suction Cannula Kit
with 3 Needles



Suction Pipe



Suction Needle
1mm



Suction Needle
1.5mm



Suction Needle
2mm



TW6-312
Height Gauge



TW6-313
Brush Stainless Steel



TW6-314
Amalgam Gun



IMPRESSION TRAYS



IMPRESSION TRAYS



- Оттисные ложки
 - Porte-empreinte
 - Abdrucklöffel
- Відбиткові ложки
 - Cubetas para impresiones
 - صواني الاطباع

PERFORATED RIM LOCK

UPPER



LOWER



SET OF 06 PCS
Upper: S, M, L
Lower: S, M, L
TW7-11

SET OF 08 PCS
Upper: XS, S, M, L
Lower: XS, S, M, L
TW7-12

SET OF 08 PCS
Upper: S, M, L, XL
Lower: S, M, L, XL
TW7-13

SET OF 10 PCS
Upper: XS, S, M, L, XL
Lower: XS, S, M, L, XL
TW7-14

All the above impression trays are available in these 5 sizes

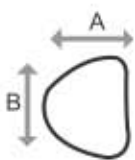

UPPER		U5	U4	U3	U2	U1
		XS	S	M	L	XL
	A	52	53	54	60	62
	B	68	69	73	75	85

LOWER		L5	L4	L3	L2	L1
		XS	S	M	L	XL
	A	52	53	54	60	62
	B	68	69	73	75	85

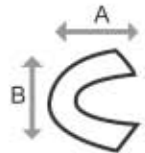

All Dimension are in mm

- Оттисковые ложки
 - Porte-empreinte
 - Abdrucklöffel
- Відбиткові ложки
 - Cubetas para impresiones
 - صواني الاطباع

SOLID RIM LOCK

UPPER



LOWER



SET OF 06 PCS
Upper: S, M, L
Lower: S, M, L
TW7-25

SET OF 08 PCS
Upper: XS, S, M, L
Lower: XS, S, M, L
TW7-26

SET OF 08 PCS
Upper: S, M, L, XL
Lower: S, M, L, XL
TW7-27

SET OF 10 PCS
Upper: XS, S, M, L, XL
Lower: XS, S, M, L, XL
TW7-28

All the above impression trays are available in these 5 sizes

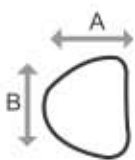

UPPER		U5	U4	U3	U2	U1
		XS	S	M	L	XL
	A	52	53	54	60	62
	B	68	69	73	75	85

LOWER		L5	L4	L3	L2	L1
		XS	S	M	L	XL
	A	52	53	54	60	62
	B	68	69	73	75	85

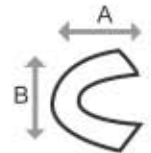

All Dimension are in mm

IMPRESSION TRAYS



- Оттисные ложки
 - Porte-empreinte
 - Abdrucklöffel
- Відбиткові ложки
 - Cubetas para impresiones
 - صواني الاطباع

PERFORATED FULL DENTURE

UPPER



LOWER



SET OF 06 PCS

Upper: S, M, L
Lower: S, M, L
TW7-37

SET OF 08 PCS

Upper: S, M, L, XL
Lower: S, M, L, XL
TW7-38

All the above impression trays are available in these 4 sizes

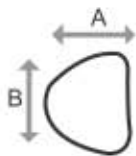

UPPER		S	M	L	XL
	A	60	64	67	70
B	70	73	76	79	

LOWER		S	M	L	XL
	A	57	60	60	64
B	70	70	73	86	

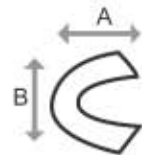

All Dimension are in mm

- Оттисные ложки
 - Porte-empreinte
 - Abdrucklöffel
- Відбиткові ложки
 - Cubetas para impresiones
 - صواني الاطباع

SOLID FULL DENTURE

UPPER



LOWER



SET OF 06 PCS

Upper: S, M, L
Lower: S, M, L
TW7-47

SET OF 08 PCS

Upper: S, M, L, XL
Lower: S, M, L, XL
TW7-48

All the above impression trays are available in these 4 sizes

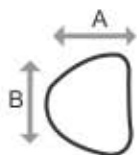

UPPER		S	M	L	XL
	A	60	64	67	70
B	70	73	76	79	

LOWER		S	S	M	XL
	A	57	60	60	64
B	70	70	73	86	

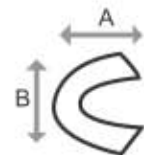

All Dimension are in mm

IMPRESSION TRAYS



- Оттисные ложки
- Відбиткові ложки
- Porte-empreinte
- Cubetas para impresiones
- Abdrucklöffel
- صواني الاطباع

SOLID FULL DENTURE

UPPER



LOWER



SET OF 06 PCS
Upper: S, M, L
Lower: S, M, L
TW7-57

SET OF 08 PCS
Upper: S, M, L, XL
Lower: S, M, L, XL
TW7-58

All the above impression trays are available in these 4 sizes

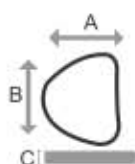

UPPER		S	M	L	XL
	A	60	64	67	70
B	70	73	76	79	

LOWER		S	M	L
	A	57	60	64
B	70	70	73	86

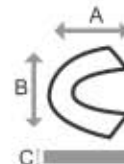

All Dimension are in mm

PERFORATED FULL DENTURE

UPPER



LOWER



SET OF 06 PCS
Upper: S, M, L
Lower: S, M, L
TW7-67

SET OF 08 PCS
Upper: S, M, L, XL
Lower: S, M, L, XL
TW7-68

- Оттисные ложки
 - Porte-empreinte
 - Abdrucklöffel
- Відбиткові ложки
 - Cubetas para impresiones
 - صواني الاطباع

UPPER



LOWER



SET OF 06 PCS
Upper: S, M, L
Lower: S, M, L
TW7-75

All the above impression trays are available in these 3 sizes

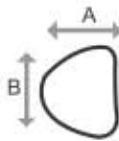

UPPER		U3	U2	U1	LOWER		L3	L2	L1
		S	M	L			S	M	L
	A	57	64	67		A	57	57	60
	B	70	71	81		B	76	79	81

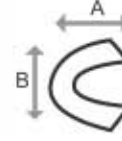

All Dimension are in mm

INDUSTRIES

UPPER



LOWER



SET OF 06 PCS
Upper: S, M, L
Lower: S, M, L
TW7-82

IMPRESSION TRAYS



- Оттисные ложки
 - Porte-empreinte
 - Abdrucklöffel
- Відбиткові ложки
 - Cubetas para impresiones
 - صوتي الاطبايع

English Pattern Mesh Type

UPPER



LOWER



SET OF 06 PCS

Upper: S, M, L
Lower: S, M, L
TW7-91

SET OF 08 PCS

Upper: S, M, L, XL
Lower: S, M, L, XL
TW7-92

All the above impression trays are available in these 4 sizes

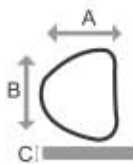

UPPER	U 1	U 2	U 3	U 4
	S	M	L	XL
A	12	13	15	15
B	50	51	55	58
C	67	72	78	80

LOWER

LOWER	L 1	L 2	L 3	L 4
	S	M	L	XL
A	14	15	15	17
B	50	51	55	60
C	70	77	79	80

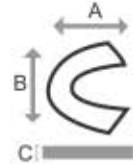

All Dimension are in mm

English Pattern Punched Type

UPPER

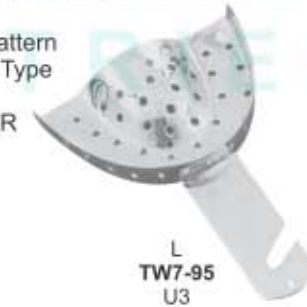

LOWER

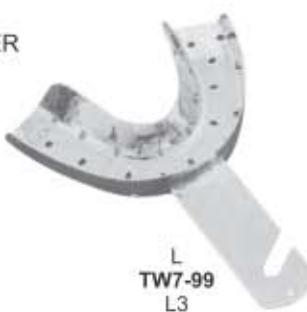

SET OF 06 PCS

Upper: S, M, L
Lower: S, M, L
TW7-101

SET OF 08 PCS

Upper: S, M, L, XL
Lower: S, M, L, XL
TW7-102

- Оттисные ложки
 - Porte-empreinte
 - Abdrucklöffel
- Відбиткові ложки
 - Cubetas para impresiones
 - صواني الاطباع

ENGLISH PATTERN SOLID TYPE

UPPER



LOWER



SET OF 06 PCS
Upper: S, M, L
Lower: S, M, L
TW7-111

SET OF 08 PCS
Upper: S, M, L, XL
Lower: S, M, L, XL
TW7-112

All the above impression trays are available in these 4 sizes

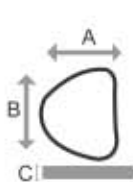

UPPER		U 1	U 2	U 3	U 4
		S	M	L	XL
A		12	13	15	15
B		50	51	55	58
C		67	72	78	80

LOWER		L 1	L 2	L 3	L 4
		S	M	L	XL
A		14	15	15	17
B		50	51	55	60
C		70	77	79	80

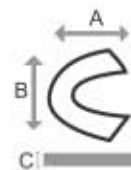

All Dimension are in mm

IMPRESSION TRAYS



- Оттисные ложки
 - Porte-empreinte
 - Abdrucklöffel
- Відбиткові ложки
 - Cubetas para impresiones
 - صواني الاطباع

SOLID FULL DENTURE

UPPER



LOWER



SET OF 06 PCS
Upper: S, M, L
Lower: S, M, L
TW7-121

SET OF 08 PCS
Upper: S, M, L, XL
Lower: S, M, L, XL
TW7-122

PERFORATED FULL DENTURE

UPPER



LOWER



SET OF 06 PCS
Upper: S, M, L
Lower: S, M, L
TW7-131

SET OF 08 PCS
Upper: S, M, L, XL
Lower: S, M, L, XL
TW7-132

- Оттисные ложки
 - Porte-empreinte
 - Abdrucklöffel
- Відбиткові ложки
 - Cubetas para impresiones
 - صواني الاطباع

ORTHODONTIAL SOLID

UPPER



S
TW7-133



M
TW7-134



L
TW7-135



XL
TW7-136

LOWER



S
TW7-137



M
TW7-138



L
TW7-139



XL
TW7-140

SET OF 06 PCS

Upper: S, M, L
Lower: S, M, L

TW7-141

SET OF 08 PCS

Upper: S, M, L, XL
Lower: S, M, L, XL

TW7-142

ORTHODONTIAL PERFORATED

UPPER



S
TW7-143



M
TW7-144



L
TW7-145



XL
TW7-146

LOWER



S
TW7-147



M
TW7-148



L
TW7-149



XL
TW7-150

SET OF 06 PCS

Upper: S, M, L
Lower: S, M, L

TW7-151

SET OF 08 PCS

Upper: S, M, L, XL
Lower: S, M, L, XL

TW7-152

IMPRESSION TRAYS



- Оттисные ложки
 - Porte-empreinte
 - Abdrucklöffel
- Відбиткові ложки
 - Cubetas para impresiones
 - صواني الاطباع

PERFORATED WITHOUT RIM LOCK

UPPER



XXS
TW7-153
U1

XS
TW7-154
U2

S
TW7-155
U3

M
TW7-156
U4

L
TW7-157
U5

XL
TW7-158
U6

LOWER

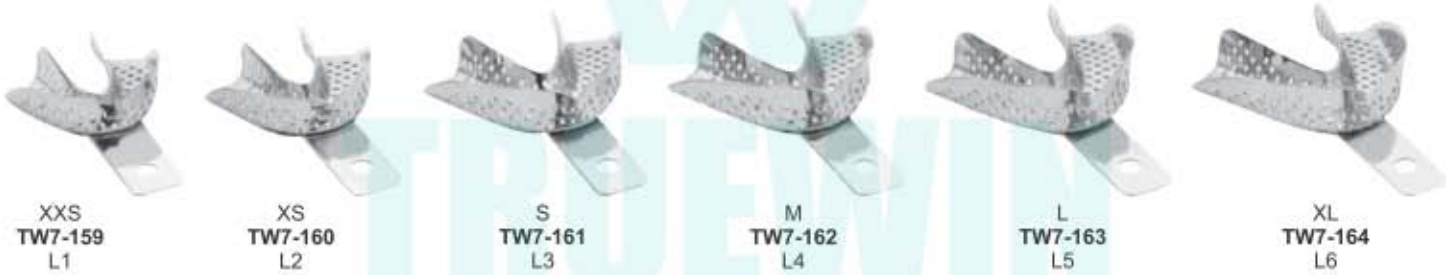

XXS
TW7-159
L1

XS
TW7-160
L2

S
TW7-161
L3

M
TW7-162
L4

L
TW7-163
L5

XL
TW7-164
L6

SET OF 06 PCS
Upper: S, M, L
Lower: S, M, L
TW7-165

SET OF 08 PCS
Upper: XS, S, M, L
Lower: XS, S, M, L
TW7-166

SET OF 08 PCS
Upper: S, M, L, XL
Lower: S, M, L, XL
TW7-167

SET OF 10 PCS
Upper: XS, S, M, L, XL
Lower: XS, S, M, L, XL
TW7-168

SET OF 12 PCS
Upper: XXS, XS, S, M, L, XL
Lower: XXS, XS, S, M, L, XL
TW7-169

All the above impression trays are available in these 6 sizes

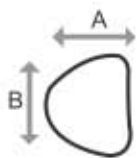

UPPER		U1	U2	U3	U4	U5	U6
		XXS	XS	S	M	L	XL
	A	61	64	66	69	71	73
	B	47	51	53	57	60	62

LOWER		L1	L2	L3	L4	L5	L6
		XXS	XS	S	M	L	XL
	A	55	60	72	74	76	78
	B	47	49	54	57	59	61

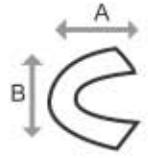

All Dimension are in mm

- Оттисные ложки
 - Porte-empreinte
 - Abdrucklöffel
- Відбиткові ложки
 - Cubetas para impresiones
 - صواني الاطباع

SOLID WITHOUT RIM LOCK

UPPER



XXS
TW7-170
U1

XS
TW7-171
U2

S
TW7-172
U3

M
TW7-173
U4

L
TW7-174
U5

XL
TW7-175
U6

LOWER



XXS
TW7-176
L1

XS
TW7-177
L2

S
TW7-178
L3

M
TW7-179
L4

L
TW7-180
L5

XL
TW7-181
L6

SET OF 06 PCS
Upper: S, M, L
Lower: S, M, L
TW7-182

SET OF 08 PCS
Upper: XS, S, M, L
Lower: XS, S, M, L
TW7-183

SET OF 08 PCS
Upper: S, M, L, XL
Lower: S, M, L, XL
TW7-184

SET OF 10 PCS
Upper: XS, S, M, L, XL
Lower: XS, S, M, L, XL
TW7-185

SET OF 12 PCS
Upper: XXS, XS, S, M, L, XL
Lower: XXS, XS, S, M, L, XL
TW7-186

All the above impression trays are available in these 6 sizes

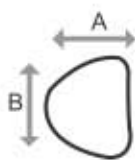

UPPER		U1	U2	U3	U4	U5	U6
		XXS	XS	S	M	L	XL
A		61	64	66	69	71	73
B		47	51	53	57	60	62

LOWER		L1	L2	L3	L4	L5	L6
		XXS	XS	S	M	L	XL
A		55	60	72	74	76	78
B		47	49	54	57	59	61

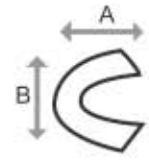

All Dimension are in mm

IMPRESSION TRAYS



- Оттисные ложки
 - Porte-empreinte
 - Abdrucklöffel
- Відбиткові ложки
 - Cubetas para impresiones
 - صواني الاطباع

PARTIAL SOLID



TW7-187 44mm
TW7-188 55mm
TW7-189 60mm
TW7-190 65mm



TW7-191



TW7-192 44mm
TW7-193 55mm
TW7-194 60mm
TW7-195 65mm



TW7-196



TW7-197

Set of 5 Pcs TW7-198

PARTIAL PERFORATED



TW7-199 44mm
TW7-200 55mm
TW7-201 60mm
TW7-202 65mm



TW7-203



TW7-204 44mm
TW7-205 55mm
TW7-206 60mm
TW7-207 65mm



TW7-208



TW7-209



TW7-210



TW7-211

Set of 7 Pcs. TW7-212

- Оттисные ложки
 - Porte-empreinte
 - Abdrucklöffel
- Відбиткові ложки
 - Cubetas para impresiones
 - صواني الانطباع



Perforated

1/2L

1/2R

TW7-213 1/2L/S
TW7-214 1/2L/M
TW7-215 1/2L/L

TW7-216 1/2R/S
TW7-217 1/2R/M
TW7-218 1/2R/L



non-Perforated

1/2L

1/2R

TW7-219 1/2L/S
TW7-220 1/2L/M
TW7-221 1/2L/L

TW7-222 1/2R/S
TW7-223 1/2R/M
TW7-224 1/2R/L



Back

Universal

TW7-225 UN/1
Front

with swivel handle and fixing screw



Universal

TW7-226 UN/1
Front

TW7-227 1

Front
with swivel handle

Back



TW7-228 1
Front



Stolley
TW7-229
ST/1

Partial occlusal stainless steel impression trays

They allow you to take an impression of two semi-arches antagonistic



with swivel handle and solid

TW7-230
OCP



TW7-231
OCG

IMPRESSION TRAYS



- Оттисные ложки
 - Porte-empreinte
 - Abdrucklöffel
- Відбиткові ложки
 - Cubetas para impresiones
 - صواني الاطبايع



	A mm.	B mm.	UPPER
U 0	59	52	
U 1	66	52	
U 2	71	62	
U 3	71	64	
U 4	80	70	



	A mm.	B mm.	LOWER
L 0	65	46	
L 1	67	50	
L 2	76	54	
L 3	79	56	
L 4	79	61	

SET OF 10 PCS
Upper: XS, S, M, L, XL
Lower: XS, S, M, L, XL
TW7-242

- Оттисные ложки
 - Porte-empainte
 - Abdrucklöffel
- Відбиткові ложки
 - Cubetas para impresiones
 - صواني الاطباع

Ehricke Stainless Steel Impression Trays

UPPER



S
TW7-243
U1



M
TW7-244
U2



L
TW7-245
U3

LOWER



S
TW7-246
L1



M
TW7-247
L2



L
TW7-248
L3

SET OF 06 PCS

Upper: S, M, L

Lower: S, M, L

TW7-249

	A mm.	B mm.	UPPER
U 1	64	46	
U 2	68	53	
U 3	79	61	

	A mm.	B mm.	LOWER
L 1	70	48	
L 2	70	53	
L 3	72	57	

IMPRESSION TRAYS



- Оттисные ложки
 - Porte-empreinte
 - Abdrucklöffel
- Відбиткові ложки
 - Cubetas para impresiones
 - صواني الاطباع

UPPER



LOWER

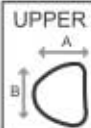

SET OF 06 PCS
Upper: S, M, L
Lower: S, M, L
TW7-256

	A mm.	B mm.	UPPER 
U 1	62	50	
U 2	70	56	
U 3	78	62	

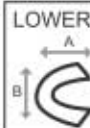
	A mm.	B mm.	LOWER 
L 1	70	55	
L 2	78	59	
L 3	86	63	



IMPRESSION TRAY BOX PACKING

- Упаковка лотка для ящиков
- Emballage de boîte de trame d'impression
- Abformlöffel Verpackung
- Упаковка для лотків із зображенням
- Embalaje de la bandeja de impresión
- الطباخ علبه صندوقی تعبیه

Impression Trays With Packing



Set of 6 Pcs



Set of 8 Pcs



Set of 10 Pcs



Set of 12 Pcs





Scalers Tray
TW8-01 200 x 100 mm



Scalers Trays
TW8-02 205 x 115 x 17 mm
TW8-03 205 x 152 x 17 mm
TW8-04 290 x 115 x 17 mm

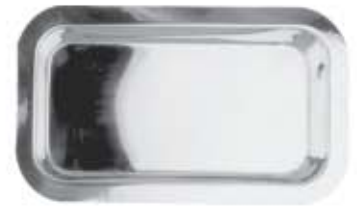

Instruments Trays
TW8-05 200 x 110 x 30 mm
TW8-06 215 x 115 x 35 mm
TW8-07 220 x 130 x 30 mm
TW8-08 230 x 125 x 35 mm
TW8-09 245 x 140 x 40 mm
TW8-10 285 x 160 x 45 mm
TW8-11 315 x 175 x 50 mm
TW8-12 330 x 185 x 50 mm



Instruments Trays
TW8-13 150 x 100 x 50 mm
TW8-14 200 x 100 x 50 mm
TW8-15 220 x 120 x 50 mm
TW8-16 240 x 140 x 50 mm
TW8-17 200 x 150 x 50 mm
TW8-18 250 x 200 x 50 mm
TW8-19 300 x 250 x 50 mm
TW8-20 300 x 200 x 50 mm
TW8-21 350 x 250 x 50 mm
TW8-22 400 x 300 x 50 mm
TW8-23 450 x 300 x 50 mm
TW8-24 450 x 350 x 50 mm



Instruments Trays With Lid
TW8-25 150 x 100 x 50 mm
TW8-26 200 x 100 x 50 mm
TW8-27 220 x 120 x 50 mm
TW8-28 240 x 140 x 50 mm
TW8-29 200 x 150 x 50 mm
TW8-30 250 x 200 x 50 mm
TW8-31 300 x 250 x 50 mm
TW8-32 300 x 200 x 50 mm
TW8-33 350 x 250 x 50 mm
TW8-34 400 x 300 x 50 mm
TW8-35 450 x 300 x 50 mm
TW8-36 450 x 350 x 50 mm



Mayo Tray Perforated
TW8-37 150 x 100 x 25 mm
TW8-38 200 x 100 x 25 mm
TW8-39 220 x 120 x 25 mm
TW8-40 240 x 140 x 25 mm
TW8-41 200 x 150 x 25 mm
TW8-42 250 x 200 x 25 mm
TW8-43 300 x 250 x 25 mm
TW8-44 300 x 200 x 25 mm
TW8-45 350 x 250 x 25 mm
TW8-46 400 x 300 x 25 mm
TW8-47 450 x 300 x 25 mm
TW8-48 450 x 350 x 25 mm



Scaler Tray
TW8-49 200 x 115 mm
TW8-50 205 x 150 mm
TW8-51 290 x 150 mm
TW8-52 300 x 200 mm



Instruments Tray Perforated
TW8-53 150 x 100 x 50 mm
TW8-54 200 x 100 x 50 mm
TW8-55 220 x 120 x 50 mm
TW8-56 240 x 140 x 50 mm
TW8-57 200 x 150 x 50 mm
TW8-58 250 x 200 x 50 mm
TW8-59 300 x 250 x 50 mm
TW8-60 300 x 200 x 50 mm
TW8-61 350 x 250 x 50 mm
TW8-62 400 x 300 x 50 mm
TW8-63 450 x 300 x 50 mm
TW8-64 450 x 350 x 50 mm

Sterilizing boxes & instruments Trays



Instruments Box with Hooks

- TW8-65 170 x 70 x 30 mm
- TW8-66 180 x 80 x 40 mm
- TW8-67 200 x 100 x 40 mm
- TW8-68 200 x 100 x 50 mm
- TW8-69 220 x 120 x 50 mm
- TW8-70 250 x 150 x 50 mm
- TW8-71 250 x 200 x 50 mm
- TW8-72 300 x 150 x 60 mm
- TW8-73 300 x 200 x 50 mm
- TW8-74 350 x 250 x 50 mm
- TW8-75 400 x 200 x 100 mm
- TW8-76 450 x 250 x 50 mm



Instruments Box

- TW8-77 170 x 70 x 30 mm
- TW8-78 180 x 80 x 40 mm
- TW8-79 200 x 100 x 40 mm
- TW8-80 200 x 100 x 50 mm
- TW8-81 220 x 120 x 50 mm
- TW8-82 250 x 150 x 50 mm
- TW8-83 250 x 200 x 50 mm
- TW8-84 300 x 150 x 60 mm
- TW8-85 300 x 200 x 50 mm
- TW8-86 350 x 250 x 50 mm
- TW8-87 400 x 200 x 100 mm
- TW8-88 450 x 250 x 50 mm



Instruments Box Perforated

- TW8-89 170 x 70 x 30 mm
- TW8-90 180 x 80 x 40 mm
- TW8-91 200 x 100 x 40 mm
- TW8-92 200 x 100 x 50 mm
- TW8-93 220 x 120 x 50 mm
- TW8-94 250 x 150 x 50 mm
- TW8-95 250 x 200 x 50 mm
- TW8-96 300 x 150 x 60 mm
- TW8-97 300 x 200 x 50 mm
- TW8-98 350 x 250 x 50 mm
- TW8-99 400 x 200 x 100 mm
- TW8-100 450 x 250 x 50 mm



Gloves Box

- TW8-101 300 x 150 mm



Catheters Tray with lid

- TW8-102 200 x 60 x 40 mm
- TW8-103 200 x 90 x 40 mm
- TW8-104 320 x 95 x 50 mm
- TW8-105 328 x 90 x 50 mm
- TW8-106 365 x 90 x 50 mm
- TW8-107 440 x 115 x 50 mm



Box With Filter

- TW8-108 100 x 50 mm
- TW8-109 250 x 150 mm
- TW8-110 150 x 65 mm
- TW8-111 200 x 100 mm
- TW8-112 300 x 200 mm



Instruments Trays With Cover

- TW8-113 210 x 110 x 50 mm
- TW8-114 240 x 160 x 50 mm
- TW8-115 300 x 180 x 50 mm
- TW8-116 360 x 210 x 50 mm
- TW8-117 400 x 230 x 55 mm

Instruments Trays Without Cover

- TW8-118 210 x 110 x 50 mm
- TW8-119 240 x 160 x 50 mm
- TW8-120 300 x 180 x 50 mm
- TW8-121 360 x 210 x 50 mm
- TW8-122 400 x 230 x 55 mm



Instruments Box with lid

- TW8-123 170 x 70 x 30 mm
- TW8-124 180 x 80 x 40 mm
- TW8-125 200 x 100 x 40 mm
- TW8-126 200 x 100 x 50 mm
- TW8-127 220 x 120 x 50 mm
- TW8-128 250 x 150 x 50 mm
- TW8-129 250 x 200 x 50 mm
- TW8-130 300 x 150 x 60 mm
- TW8-131 300 x 200 x 50 mm
- TW8-132 350 x 250 x 50 mm
- TW8-133 400 x 200 x 100 mm
- TW8-134 450 x 250 x 50 mm



Kidney Tray
 TW8-135 160 mm
 TW8-136 200 mm
 TW8-137 250 mm
 TW8-138 280 mm
 TW8-139 300 mm



Kidney Tray Shallow
 TW8-140 170 mm
 TW8-141 220 mm
 TW8-142 240 mm



Kidney Tray With Cover
 TW8-143 160 mm
 TW8-144 200 mm
 TW8-145 250 mm
 TW8-146 280 mm
 TW8-147 300 mm



Kidney Tray
 TW8-148 160 mm
 TW8-149 200 mm
 TW8-150 250 mm
 TW8-151 280 mm
 TW8-152 300 mm



Forceps Jars
 TW8-153 30 x 90 mm
 TW8-154 50 x 100 mm
 TW8-155 50 x 130 mm
 TW8-156 50 x 175 mm
 TW8-157 75 x 100 mm
 TW8-158 75 x 130 mm
 TW8-159 75 x 175 mm
 TW8-160 100 x 175 mm
 TW8-161 100 x 200 mm



Methot Jar Without Lid
 TW8-162



Dressing Jar / Cotton Container
 TW8-163 80 x 80 mm
 TW8-164 100 x 60 mm
 TW8-165 100 x 80 mm
 TW8-166 100 x 100 mm
 TW8-167 120 x 80 mm
 TW8-168 120 x 100 mm
 TW8-169 150 x 100 mm
 TW8-170 150 x 150 mm
 TW8-171 180 x 150 mm
 TW8-172 180 x 180 mm
 TW8-173 200 x 200 mm
 TW8-174 240 x 240 mm



Sputum Cup
 TW8-175



Dressing Jar With Lid & Knob
 TW8-176 80 x 80 mm
 TW8-177 90 x 90 mm
 TW8-178 100 x 100 mm
 TW8-179 120 x 120 mm
 TW8-180 100 x 130 mm
 TW8-181 150 x 150 mm
 TW8-182 125 x 170 mm



Round Bowls
 TW8-183 80 x 35 mm
 TW8-184 125 x 60 mm



Spirit Lamp
TW8-185



Spirit Lamp
TW8-186



Spirit Lamp
TW8-187



Cotton Holding Jar
TW8-188



Cotton Holder
TW8-189



Cotton Wool Dispenser Acc.
to Methot
TW8-190



Needle Sterilization Tub
TW8-191



Round Endodontic Boxes
complete with lid
TW8-192 Ø mm. 94 - h. mm. 70



Endodontic Box
TW8-193



Round Sterilizer Drum

- TW8-194 mm. Ø 80 x 80 H
- TW8-195 mm. Ø 125 x 80 H
- TW8-196 mm. Ø 125 x 100 H
- TW8-197 mm. Ø 125 x 125 H
- TW8-198 mm. Ø 150 x 80 H
- TW8-199 mm. Ø 150 x 100 H
- TW8-200 mm. Ø 150 x 130 H
- TW8-201 mm. Ø 150 x 150 H
- TW8-202 mm. Ø 150 x 190 H
- TW8-203 mm. Ø 190 x 125 H
- TW8-204 mm. Ø 190 x 145 H
- TW8-205 mm. Ø 190 x 165 H
- TW8-206 mm. Ø 190 x 190 H
- TW8-207 mm. Ø 190 x 240 H
- TW8-208 mm. Ø 190 x 290 H
- TW8-209 mm. Ø 240 x 120 H
- TW8-210 mm. Ø 240 x 145 H
- TW8-211 mm. Ø 240 x 165 H
- TW8-212 mm. Ø 240 x 190 H
- TW8-213 mm. Ø 240 x 240 H
- TW8-214 mm. Ø 240 x 290 H
- TW8-215 mm. Ø 240 x 340 H
- TW8-216 mm. Ø 240 x 390 H
- TW8-217 mm. Ø 290 x 145 H
- TW8-218 mm. Ø 290 x 165 H
- TW8-219 mm. Ø 290 x 190 H
- TW8-220 mm. Ø 290 x 240 H
- TW8-221 mm. Ø 290 x 290 H
- TW8-222 mm. Ø 290 x 340 H
- TW8-223 mm. Ø 290 x 390 H
- TW8-224 mm. Ø 340 x 145 H
- TW8-225 mm. Ø 340 x 165 H
- TW8-226 mm. Ø 340 x 190 H
- TW8-227 mm. Ø 340 x 240 H
- TW8-228 mm. Ø 340 x 290 H
- TW8-229 mm. Ø 340 x 340 H
- TW8-230 mm. Ø 340 x 390 H
- TW8-231 mm. Ø 390 x 140 H
- TW8-232 mm. Ø 390 x 165 H
- TW8-233 mm. Ø 390 x 190 H
- TW8-234 mm. Ø 390 x 240 H
- TW8-235 mm. Ø 390 x 290 H
- TW8-236 mm. Ø 390 x 340 H
- TW8-237 mm. Ø 390 x 390 H
- TW8-238 mm. Ø 390 x 490 H

Round Sterilizer Drums "Filter"

- TW8-239 mm. Ø 80 x 80 H
- TW8-240 mm. Ø 125 x 80 H
- TW8-241 mm. Ø 125 x 100 H
- TW8-242 mm. Ø 125 x 125 H
- TW8-243 mm. Ø 150 x 100 H
- TW8-244 mm. Ø 150 x 130 H
- TW8-245 mm. Ø 150 x 150 H
- TW8-246 mm. Ø 150 x 190 H
- TW8-247 mm. Ø 190 x 145 H
- TW8-248 mm. Ø 190 x 165 H
- TW8-249 mm. Ø 190 x 190 H
- TW8-250 mm. Ø 190 x 240 H
- TW8-251 mm. Ø 240 x 145 H
- TW8-252 mm. Ø 240 x 165 H
- TW8-253 mm. Ø 240 x 190 H
- TW8-254 mm. Ø 240 x 240 H
- TW8-255 mm. Ø 240 x 290 H
- TW8-256 mm. Ø 240 x 340 H
- TW8-257 mm. Ø 240 x 390 H
- TW8-258 mm. Ø 290 x 145 H
- TW8-259 mm. Ø 290 x 165 H
- TW8-260 mm. Ø 290 x 190 H
- TW8-261 mm. Ø 290 x 240 H
- TW8-262 mm. Ø 290 x 290 H
- TW8-263 mm. Ø 290 x 340 H
- TW8-264 mm. Ø 290 x 390 H
- TW8-265 mm. Ø 340 x 145 H
- TW8-266 mm. Ø 340 x 165 H
- TW8-267 mm. Ø 340 x 190 H
- TW8-268 mm. Ø 340 x 240 H
- TW8-269 mm. Ø 340 x 290 H
- TW8-270 mm. Ø 390 x 140 H
- TW8-271 mm. Ø 390 x 165 H
- TW8-272 mm. Ø 390 x 190 H
- TW8-273 mm. Ø 390 x 240 H
- TW8-274 mm. Ø 390 x 290 H
- TW8-275 mm. Ø 390 x 340 H
- TW8-276 mm. Ø 390 x 490 H

Round Bowls With Cover

- TW8-277 Ø 40 mm ml.30
- TW8-278 Ø 60 mm ml.50
- TW8-279 Ø 80 mm ml.150
- TW8-280 Ø 100 mm ml.250
- TW8-281 Ø 120 mm ml.450
- TW8-282 Ø 150 mm ml.750
- TW8-283 Ø 180 mm ml.1500
- TW8-284 Ø 200 mm ml.2100
- TW8-285 Ø 250 mm ml.3500

Round Bowls With Out Cover

- TW8-286 Ø 40 mm ml.30
- TW8-287 Ø 60 mm ml.50
- TW8-288 Ø 80 mm ml.150
- TW8-289 Ø 100 mm ml.250
- TW8-290 Ø 120 mm ml.450
- TW8-291 Ø 150 mm ml.750
- TW8-292 Ø 180 mm ml.1500
- TW8-293 Ø 200 mm ml.2100
- TW8-294 Ø 250 mm ml.3500

INSTRUMENTS MANAGEMENT SYSTEM

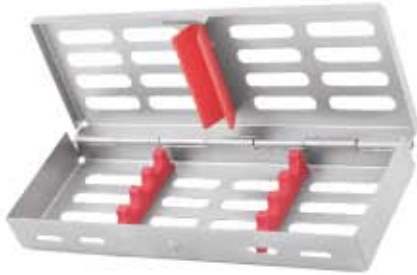

Cassette For 4 Instruments
TW8-295



Cassette For 5 Instruments
TW8-296



Cassette For 6 Instruments
TW8-297



Cassette For 7 Instruments
TW8-298



Cassette For 10 Instruments
TW8-299



Cassette For 20 Instruments
TW8-300



Cassette For Extraction Forceps
TW8-301

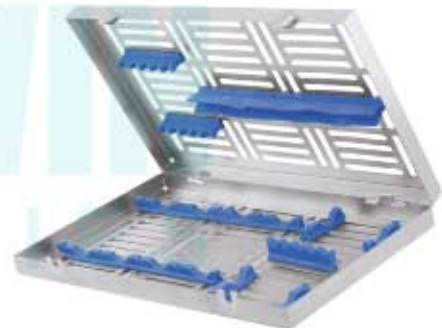

Cassette For Root Elevator
TW8-302



TW8-303
Cassette Tray
15 Pcs



TW8-304
Cassette Tray
15 Pcs

STERILIZING MESH TRAY

Different sizes & dimensions are available at buyer's demand



MESH TRAYS
TW8-305
Different sizes & dimensions are available at buyer's demand



MESH TRAYS
TW8-306
05 Pcs



MESH TRAYS
TW8-307
07 Pcs



MESH TRAYS
TW8-308
10 Pcs

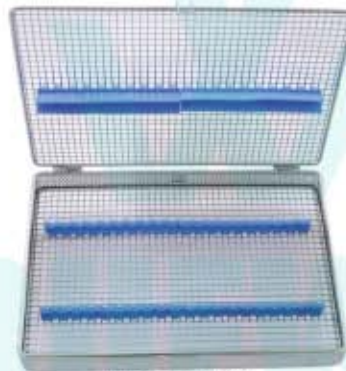

MESH TRAYS
TW8-309
20 Pcs



TW8-310
Mesh Cassettes
5 Pieces, 7 Pieces, 10 Pieces,
15 Pieces & 20 Pieces

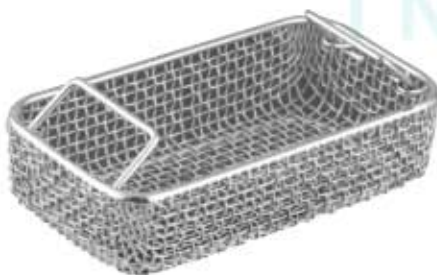

MESH TRAY
TW8-311 240x130x50mm
TW8-312 240x130x60mm
TW8-313 240x250x50mm
TW8-314 240x250x60mm
TW8-315 480x250x50mm
TW8-316 480x250x60mm
TW8-317 480x250x70mm



MESH TRAY
TW8-318 240x250x 50mm
TW8-319 240x250x 60mm
TW8-320 240x250x 70mm
TW8-321 480x250x 50mm
TW8-322 480x250x 60mm
TW8-323 480x250x 70mm
TW8-324 480x250x100mm



MESH TRAY
TW8-325 240x250x50mm
TW8-326 240x250x60mm
TW8-327 240x250x70mm
TW8-328 280x250x50mm
TW8-329 280x250x60mm



MESH TRAY
TW8-330 280x250x 70mm
TW8-331 280x250x100mm
TW8-332 280x250x 50mm
TW8-333 280x280x 60mm
TW8-334 280x280x 70mm
TW8-335 300x280x 60mm



TW8-336
18×7×3.5cm
5 Instruments Cassette
Detachable Lids
+
5 Instruments Cassette Hinged
Lids with button Lock



TW8-340
29×18.5×3.5cm
20 Instruments Cassette Hinged
Lids with surgical kit fitting,
button lock



TW8-344
18.5×14×3.0cm
Clips in cassette for 10
instruments, fully
opened design



TW8-337
29×18.5×3.5cm
20 Instruments Cassette
Detachable Lids
+
20 Instruments Cassette Hinged
Lids with button Lock



TW8-341
10×13×2.2cm
10 Instruments Cassette Hinged
Lids, Click Lock Available in 2
designs



TW8-345
18×11×3.5cm
Extra large cassette for 6
Instruments, with compartment
for small parts hinged lids



TW8-338
29×18.5×3.5cm
20 Instruments Cassette Detachable
Lids with elevator fitting
+
20 Instruments Cassette Hinged
Lids with elevator fitting , button lock



TW8-342
18×9×2.2cm
7 Instruments Cassette Hinged
Lids, Click Lock, Available in 2
designs



TW8-346
21×14×3.5cm
15 Instruments cassette,
Detachable lids, button lock



TW8-339
29×18.5×3.5cm
20 Instruments Cassette
Detachable Lids with surgical
kit fitting with button lock



TW8-343
5 Instruments Cassette
Detachable Lids
+
5 Instruments Cassette
Hinged Lids with button
Lock



TW8-347
21×14×3.5cm
15 Instruments cassette,
detachable lids, button
lock, with fitting of micro
surgery kit



TW8-348
21x14x4.5cm
8 pcs luxator/elevator
cassette, Detachable
lids, button lock



TW8-352
12 Instruments Cassette
Detachable Lids
+
12 Instruments Cassette
Hinged Lids with button
Lock



TW8-356
Instruments Tray Perforated
288 x 187 x 40 mm



TW8-349
15x9x5cm
Box for dental implant tools and
surgical kits, Capacity:8
tools, 18 tools, 24 Tools, 58 Tools
+ removable compartment



TW8-353



Instruments Tray Perforated Base
TW8-357 288 x 187 x 40 mm



TW8-350
10 Instruments Cassette
Detachable Lids
+
10 Instruments Cassette Hinged
Lids with button Lock



TW8-354



Instruments Tray Solid Base
TW8-358 288 x 187 x 40 mm



TW8-351
5 Instruments Cassette
Detachable Lids
+
5 Instruments Cassette Hinged
Lids with button Lock



TW8-355

INDEX

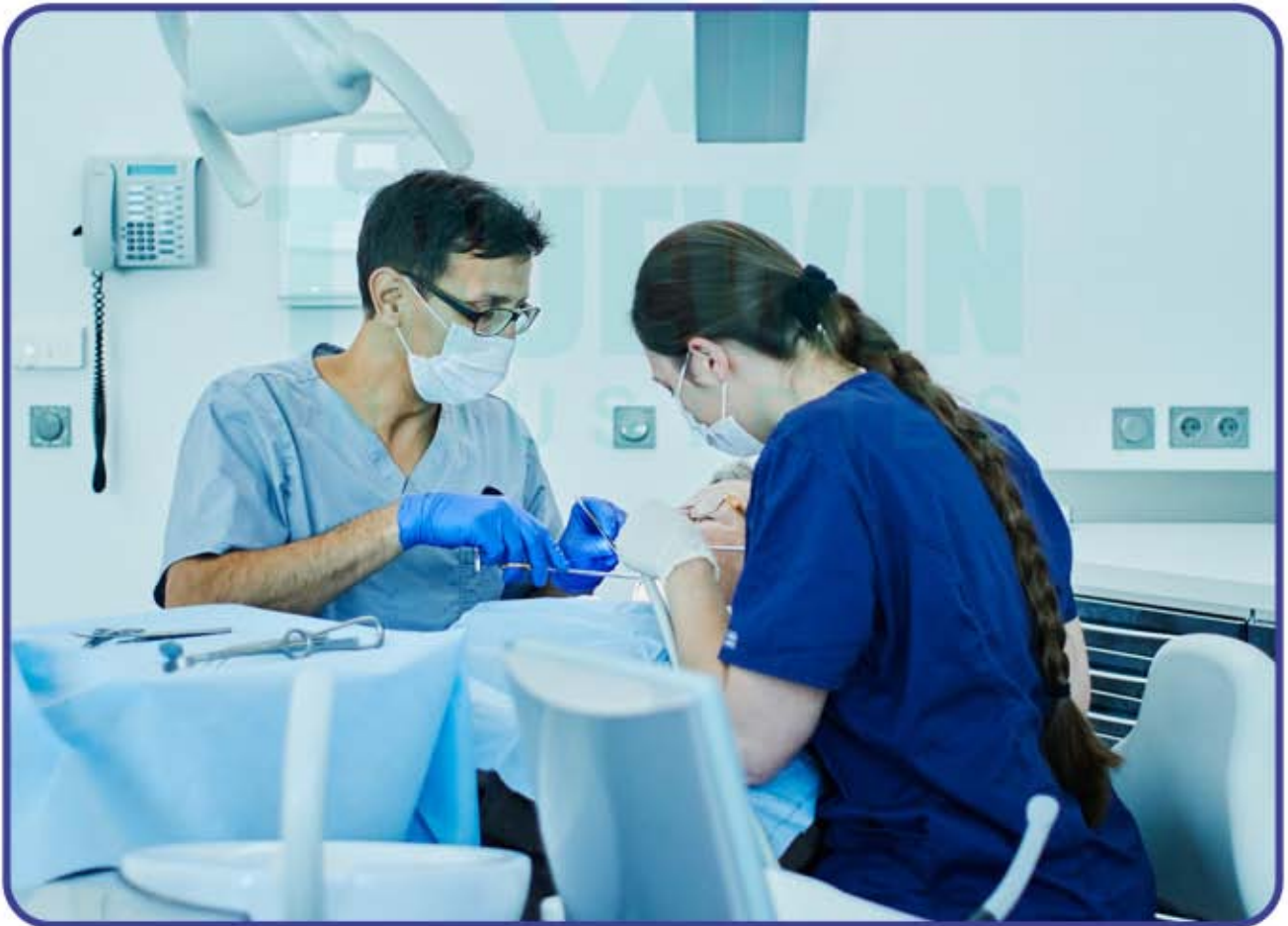

DESCRIPTION	PAGE #	DESCRIPTION	PAGE #
A			
ADAMS PLIERS FOR BENDING WIRE ARCHES	185	BASINS FOR BONE	232
ADAMS PLIERS FOR HOOKS AND BENDING	195	BAUMGARTER NEEDLE HOLDERS TC	153
ADERER CLAMP THREE JAW WIRE PLIER	195	BAUMGARTNER NEEDLE HOLDERS	155
ADERER FACEBOW LOOP FORMING PLIERS	189	BAYONET ROOTS ELEVATOR SET	51
ADERER LARGE WIRE BENDING PLIERS	184	BEALE WAX AND MODELLING CARVERS	125
ADERER PLIER	184	BEEBEE CROWN SCISSORS	147
ADHESIVE REMOVING PLIERS TC	193	BEEBEE SCISSORS TC	149
ADSON BROWN TWEEZERS	66	BEIN ROOT ELEVATOR	44,45, 53 TO 56
ADSON CARBIDE TIPPED TISSUE FORCEPS	227	BENDING PLIER	195
ADSON NEEDLE HOLDERS	155	BENNET PLASTIC FILLING INSTRUMENTS	85
ADSON TISSUE FORCEPS	227	BERTEN ROOT ELEVATOR	54
ADSON TWEEZERS	66	BEYER BONE ROUNGER	175 TO 176
ADSON-TC TWEEZERS	66	BICUSPIDS AND MOLARS WITH CONCAVE BEAKS	191
ALBRECHT EXTRACTING FORCEPS BABY	19	BIRD BEAK PLIER FOR BENDING	195
ALGINATE & PLASTER SPATULAS	130	BIRD BEAK PLIER FOR LIGHT WIRE BENDING ROUND,	195
ALLEN 9A PERIOSTEEL ELEVATORS	168	BIRD'S BEAK CLAW WITH CUTTER	191
ALLIS 4:5 TISSUE CLAMPS	152	BLACK FILLING INSTRUMENTS	91
ALLIS 6:7 TISSUE CLAMPS	152	BLACK TITANIUM COLOUR COATED INSTRUMENTS	204 TO 208
ALLIS-BABY 3:4 TISSUE CLAMPS	152	BLADE AND PUSHER	220
AMALGAM AND PLASTIC FILLING INSTRUMENTS	79 TO 81	BLUMENTHAL BONE ROUNGER	174
AMALGAM CARRIERS	165	BÖHM PLIERS FOR TELESCOPE CROWNS DIAMOND POINTS COATED,	177
AMALGAM GUN	237	BOLEY GAUGE STAINLESS STEEL	203
AMALGAM INSTRUMENTS	164,165	BONE BRACKET GAUGE	179
AMALGAM INSTRUMENTS AND BURNISHERS	82,83	BONE CARRIER	218
AMALGAM INSTRUMENTS ENGLISH PATTERN	164	BONE CRUSHER	234
AMALGAM INSTRUMENTS GERMAN PATTERN	164	BONE CRUSHER METAL WITH TITANIUM CRUSHER	232
AMALGAM INSTRUMENTS SWISS PATTERN	164	BONE EXPANDER KIT	235
AMALGAM WELL AMALGAM INSTRUMENTS	165	BONE EXPANDER SCREW & SURGICAL KITS	235
AMALGAM WELL STAINLESS STEEL	163	BONE FILES	166
AMSTERDAM TWEEZERS	65	BONE GRAFT/CARRIER T	222
ANGLE PLIER	184	BONE GRAFTING INSTRUMENTS	221
ANISWORTH RUBBER DAM CLAMPS FORCEPS	157	BONE GRAFTING INSTRUMENTS COMPACTOR /TAMPERS	219
ANTERIOR PERIODONTAL PROBES	77	BONE INJECTORS, COLLECTORS & SUCTION TUBE	236
ANTKOVIK WAX KNIVES	129	BONE MILL	232
ANVIL DENTAL LABORATORY INSTRUMENT	133	BONE ROUNGER	174
APEX FORCEPS DEEP ROOT PICK	26, 27	BONE SCRAPER RASPATOR	223
APEXO ROOT ELEVATOR	42, 43	BONE SCRAPER STRAIGHT & CURVED	232
APEXO ROOT ELEVATORS	50	BONE SPOON/ PACKER	219
APICAL ROOT ELEVATORS	46	BONE THICKNESS GAUGE	179, 203
ARCH BENDING PLIER	195	BONE UNIVERSAL KIT	235
ARCH COUNTING PLIER GROOVED	186	BOX FOR DENTAL IMPLANT TOOLS AND SURGICAL KITS	264
ARROW CLASP FORMING PLIERS	190	BOX WITH FILTER	257
ARTHUR ROOT FRAGMENTS	18	BOYNTON NEEDLE HOLDER	156
ARTICULATORS	131 TO 134	BRACKET REMOVING PLIER	188
A-TRAUMATIC EXTRACTION FORCEPS	24	BRACKET REMOVING PLIER CURVED	188
ATRAUMATIC TWEEZERS	65	BRACKET REMOVING PLIERS ANGLED TC	193
B			
BABY TOOTH EXTRACTION FORCEPS	15	BRACKET REMOVING PLIERS STRAIGHT TC	193
BACKHAUS FORCEPS	151	BREWER RUBBER DAM CLAMPS FORCEPS	157
BACKHAUS TOWEL CLAMPS	151	BRUSH STAINLESS STEEL	237
BAND PUSHER	161		
BAND REMOVING PLIER	187		
BAND REMOVING PLIERS TC	193		
BAND SEATING & REMOVING INSTRUMENTS	183		

DESCRIPTION	PAGE #	DESCRIPTION	PAGE #
BUCK PERIODONTAL FILES	101	CRANE KAPLAN TWEEZERS	66
BUCK PERIODONTAL FILES HOLLOW HANDLE .	102	CRANE-KAPLAN PERIODONTAL INSTRUMENTS	109
BUFFALO PLASTER KNIVES	128	CRANE-KAPLAN PERIODONTAL INSTRUMENTS HOLLOW HANDLE	112
BUSER PERIOSTEEL ELEVATORS	168	CRILE NEEDLE HOLDERS TC	153
C		CRILE-WOOD NEEDLE HOLDERS	155
CARRY FORCEPS	228	CRILE-WOOD NEEDLE HOLDERS TC.....	153
CARVERS INSTRUMENTS	88 TO 90	CROWN & SHELL PLIER	187
CASSETTE FOR EXTRACTION FORCEPS	261	CROWN PLIER	177
CASSETTE FOR INSTRUMENTS	261, 263	CROWN REMOVER	161, 177
CASSETTE FOR ROOT ELEVATOR	261	CROWN SCISSORS	147
CASTROVIEJO SCISSORS.....	146	CROWN SPREADER	161
CASTROVIEJO NEEDLE HOLDER TC.....	154	CRUCIBLE TONGS DEPRESSOR.....	178
CASTROVIEJO NEEDLE HOLDERS	155	CRYER ROOTS ELEVATOR	53
CATHETERS TRAY WITH LID.....	257	CRYER EXTRACTING FORCEPS (AMERICAN PATTERN)	32
CEMENT SPATULA	98	CRYER ROOT ELEVATOR	48, 54
CEMENT SPATULAS	124	D	
CERI SAW	178	DE LA ROSA PLIERS	186
CHEATLE TISSUE CLAMPS	152	DEAN SCISSORS.....	145
CHEEK RETRACTOR	138	DEBAKEY ATRAUMATIC TISSUE FORCEPS	227
CHEEK RETRACTOR AND TONGUE PUSHERS BISHOP WITH COMFORTABLE	140	DEEP GRIPE EXTRACTING FORCEPS	24
CHEEK RETRACTOR COMBINATION	140	DEEP GRIPPING ROOT FORCEPS	17
CHEEK RETRACTOR EASY TO BEND BY HAND .	140	DEEP ROOT PICK FORCEPS	25 TO 27
CHEEK RETRACTOR IVORY WIDTH ADJUSTABLE & FLEXABLE	140	DELICATE NEEDLE HOLDERS	155
CHEEK RETRACTOR LONG	140	DELUXE BRACKET HOLDER TWEEZERS	180
CHEEK RETRACTOR TONGUE DEPRESSOR	140	DENHARD CHEEK RETRACTORS.....	139
CHEEK RETRACTORS	139	DENTAL SCISSORS	147
CHEEK RETRACTORS COMBINATION	141	DENTAL SYRINGES.....	170-173
CHIP BLOWER	164	DENTINS REMOVALS EXCAVATORS	94
CHIPPING RASPATORY	225	DEPTH & GINGIVAL GAUGES	202
CHISELES, BONE FILES & SPOONE CURETTE ..	166	DERF NEEDLE HOLDERS	155
CINCH BACK / TIE BACK DISTAL END PLIERS Tc	194	DERF NEEDLE HOLDERS TC	153
CLEOIDSN FILLING INSTRUMENTS	90	DETAILING STEP PLIERS BENDING PLIERS TC .	194
CLEVELAND BONE ROUNGER	175	DIEFFENBACH SCALPEL KNIVES	136
COARSE SUCTION TUBES	236	DIRECT BOND BRACKET HOLDER TWEEZERS .	180
COLEMAN ROOT ELEVATOR	52	DIRECT BRACKET REMOVER TC. GOLD.	198
COLLEGE PLIERS WITH LOCK TWEEZERS	65	DISTAL END CUTTER TC. GOLD.	197
COLLINS TONGUE FORCEPS	151	DISTAL END CUTTER WITH SAFETY HOLD TC ..	192
COMELLAS FORCEPS	38	DISTAL END CUTTER, SAFETY HOLD PLIER (IDEAL FOR CUTTING WIRE) TC. GOLD.	197
COMPACTOR	221	DISTAL FILLING INSTRUMENTS	91
COMPOSITE GOLD COATED INSTRUMENTS	86	DOUBLE ENDED TAMPERS	182
COMPOSITE GOLD COATED TIP FILLING INSTRUMENTS	87	DOUBLE ROUNDED JAW BENDING PLIERS, HOOKS AND WIRE	195
COMPOSITE INSTRUMENTS TITANIUM BLUE ENDODONTIC	123	DRESSING FORCEPS TWEEZERS	66
CONE-SOCKET MAGNIFYING MOUTH MIRRORS	63	DRESSING JAR / COTTON CONTAINER	258
CONE-SOCKET PLAIN MOUTH MIRRORS	63	DRESSING JAR WITH LID & KNOB	258
CONIQUES CURVED SET OF 5 PIECES	230	E	
CONIQUES SET OF 5 PIECES	229	ELASTIC INSTRUMENTS	181
CONTOURING PLIER	186, 195	ELASTIC SEAPARATING PLIER	157, 199
CONVEXES CURVED SET OF 5 PIECES	230	ELASTOMERIC LIGATURE PLACING FORCEPS WITH GROOVE FALCON	199
CONVEXES SET OF 5 PIECES	229	ELASTOMERIC SEPARATOR PLACING PLIERS .	191
COTTON HOLDER	259	ELLIOT MATRIX RETAINERS	163
COTTON HOLDING JAR	259	ENAMEL INSTRUMENTS	91
COTTON WOOL DISPENSER ACC.	259		
COUPLAND ROOT ELEVATORS	46		

DESCRIPTION	PAGE #
ENDO FINGER RULER SPAN	
MEASURE SCALE	179
ENDODONTIC BOX	259
ENDODONTIC EXCAVATORS	94
ERMERT WAX KNIVES	129
EXAMINATION SETS.....	68
EXAVATOR	98
ECAVATORS	94 TO 96
EXPLORER ,PROBES	97
EXPLORERS	69 TO 75
EXPLORERS INSTRUMENTS HOLLOW HANDLE	.71
EXTRACTING FORCEPS (AMERICAN PATTERN)	28 TO 37
EXTRACTING FORCEPS (ENGLISH PATTERN)	01 TO 14 & 17, 22 TO 27
EXTRACTING FORCEPS (FOR CHILDREN)	15, 19, 20, 21
EXTRACTING FORCEPS CHILDREN PATTERN SET	
OF 10 PIECES	40
EXTRACTING FORCEPS KITS GOLD	
COATED SET OF 25 PCS	41
EXTRACTING FORCEPS KITS SET OF 37 PCS	41
EXTRACTING FORCEPS SET OF 10 PIECES	39
EXTRACTING FORCEPS SET OF 13 PIECES	40
F	
FAHNENSTOCK WAX KNIVES	127
FALCON BEAK CONTOURING PLIER.	185, 195
FARABEUF RETRACTOR	142
FEDI PERIODONTAL CHISELS.....	118
FELDMAN RETRACTOR	142
FILLING INSTRUMENTS	79, 92, 98
FLAGG TWEEZERS	65
FLAT NOSE PLIERS	185
FLAT NOSE PLIERS BOT SIDES SMOOTH	190
FLAT NOSE PLIERS BOTH SIDES TC	190
FLOHR ROOTS ELEVATOR	46, 53, 54
FLUSH-CUT DISTAL END CUTTER	
WITH SAFETY HOLD TC	192
FOERSTER DRESSING FORCEPS	151
FOR METAL PLASTER SHEARS	178
FOR PLASTER PLASTER SHEARS	178
FORCEPS FOR PLACING DENTALASTICS	200
FRAHM FILLING INSTRUMENTS	89
FRAZIER SUCTION TUBES	236
FREER PERIODONTAL INSTRUMENTS	169
FREER RASPATOR	223
FREER CHISELES & BONE FILES.....	166
FRET SAW PLASTER SHEARS	178
FRIEDMAN BONE ROUNGER	175
FRIEDMANN ROOTS ELEVATOR	49
FURRER COPPER RING REMOVING PLIER	177
G	
GAUGE FOR MEASURING DISTANCES	203
GERALD TWEEZERS	66
GILLES TWEEZERS	65
GILLIES NEEDLE HOLDER WITH SCISSORS	156

DESCRIPTION	PAGE #
GILLIES NEEDLE HOLDER WITH SCISSORS TC.	154
GLICK BLADE/PLUGGER	78
GLOVES BOX	257
GOLDMAN FOX EXPLORERS	71, 72
GOLDMAN FOX WILLIAMS EXPLORERS	72
GOLDMAN PERIODONTAL INSTRUMENTS ..	108, 111
GOLDMAN-FOX PERIODONTAL INSTRUMENTS	169
GOLDMAN-FOX SAW EDGE, SCISSORS	144
GOLDMAN-FOX SCISSORS TC	148
GOSLEE FLAT NOSE PLIERS	190
GRACEY CURETTES AFTER FIVE	107
GRACEY CURETTES HOLLOW HANDLE	104
GRACEY CURETTES MINI FIVE	107
GRACEY CURETTES SOLID HANDLE	103
GRACEY SET OF 7 PCS HOLLOW HANDLE	105
GRACEY SET OF 7 PCS SOFT GRIP	106
GRADED HANDLE HYLIN CARVER	126
GRAFT MATERIAL SPOON CONCAVE	219
GRAFT PACKER, CONCAVE TIPS	219
GRAFT PACKER, SERRATED TIPS	219
GRAFT PACKER, SMOOTH TIPS	219
GRIPPER TISSUE FORCEPS TC	227
GRITMAN WAX AND MODELLING CARVERS	125
GROOVED FINE PLIER	188
GROSS MAIER DRESSING FORCEPS	151
GUM SCISSORS	143
GUM SCISSORS TC	149
H	
HAEMOSTATIC FORCEPS	150
HAEMOSTATIC FORCEPS & TOWEL CLAMPS	151
HALSEY NEEDLE HOLDERS	155
HALSEY NEEDLE HOLDERS TC.....	153
HALSTEAD MOSQUITO FORCEPS.....	150
HALTEPINZETTE WITH LOCK	228
HAMMER HEAD DISTAL END BENDING PLIERS	.194
HAMMER WITH WOODEN HANDLE	178
HANDLES FOR MOUTH MIRRORS	64
HARD WIRE CUTTER	192
HARD WIRE CUTTER, 15° ANGLED TC	192
HARD WIRE CUTTER, STRAIGHT TC	192
HARRIS EXTRACTING FORCEPS	29
HARTMANN (BABY MOSQUITO)	
HAEMOSTATIC FORCEPS	150
HATCHES FILLING INSTRUMENTS	91
HEAT CARRIERS	76
HEBER ROOTS ELEVATOR	56
HEIDBRINK ROOT APPEX ELEVATOR	59
HEIDBRINK ROOT ELEVATOR	49, 58
HEIDBRINK ROOTS ELEVATOR	
WARWICK-JAMES	59
HEIDEMANN SPATULAS	93
HEIGHT GAUGE	237
HEIGHT GAUGE ALUMINUM	179
HEIGHT GAUGE STAINLESS STEEL	179
HEISS HAEMOSTATIC FORCEPS	150
HEMINGWAY BONE CURETTE OVAL SHAPE.....	120
HEMINGWAY TWEEZERS	66

DESCRIPTION	PAGE #	DESCRIPTION	PAGE #
HENAHAN EXTRACTING FORCEPS	34	IVORY WITH SHIELDS MATRIX RETAINERS	163
HEX DRIVER	233	IVORY WITHOUT SHIELDS MATRIX RETAINERS	163
HEX TORQUE WRENCH	233	IWANSON SPRING CALIPER	203
HIRSCHFELD PERIODONTAL FILES	101, 102	IWANSON SPRING CALIPER FOR METAL	203
HMG HEISTER MOUTH GAGS	138	J	
HOLLENBACK FILLING INSTRUMENTS	79, 88	JACQUETTE PERIODONTAL INSTRUMENTS	109,112
HOLLOW WARE INSTRUMENTS	256	JACQUETTE SCALERS	109
HOOK CRIMPING PLIER ANGLED TC. GOLD.	197	JACQUETTE SCALERS HOLLOW HANDLE	112
HOOK WAX KNIVES	129	JARABAK PLIER	189
HOW ANGLED UTILITY PLIERS TC	193	JENNINGS CHEEK RETRACTORS	139
HOW PLIER CURVED	185	JEWELLERY TWEEZERS	67
HOW STRAIGHT UTILITY PLIERS TC	193	JOHNSON CONTOURING PLIERS	185
HOWARD 9H PERIOSTEEL ELEVATORS	168	JOHNSON PLIERS	195
HULL EXTRACTING FORCEPS	33	JONES TOWEL CLAMPS	151
HYGIENIST JACQUETTE PERIODONTAL INSTRUMENTS	109	JOSEPH SCISSORS.....	144, 145
HYGIENIST JACQUETTE PERIODONTAL INSTRUMENTS HOLLOW HANDLE	112	K	
HYGIENIST PERIODONTAL INSTRUMENTS	108	KELLS EXTRACTING FORCEPS	33
HYGIENIST PERIODONTAL INSTRUMENTS HOLLOW HANDLE.....	111	KELLY SCISSORS	145
HYGIENIST-TOWNER PERIODONTAL INSTRUMENTS	108	KELLY HAEMOSTATIC FORCEPS	150
HYGIENIST-TOWNER PERIODONTAL INSTRUMENTS HOLLOW HANDLE.....	111	KELLY SCISSORS TC	149
HYLIN CARVERS INSTRUMENTS	126	KELLY-RANKIN HAEMOSTATIC FORCEPS	150
HYLIN ROOTS ELEVATOR	52	KERRISON BONE ROUNGER	174
HYLIN-CERAMICA CARVERS INSTRUMENTS	126	KEY RINGS	162
HYLIN-LE CRON CARVERS INSTRUMENTS	126	KEYS FOR IMPLANT SCREW	233
I		KIDNEY TRAY	258
IMPLANT DEPTH GAUGE	202	KIDNEY TRAY SHALLOW	258
IMPLANT DEPTH GAUGE & KEY	202	KIDNEY TRAY WITH COVER	258
IMPLANT GAGES	202	KILNER (RAGNELL) SCISSORS.....	144
IMPLANTOLOGY	202	KOEHLER LUXATION FORCEPS	19
IMPLANTSURGICAL CHISELS	217	KOPP ROOTS ELEVATOR	55, 56
IMPRESSION TRAYS	238 TO 255	KRAMER NEVINS SINUS LIFT	216
INSTRUMENTS BOX	257	KRAMER-NEVINS CHISELS.....	19
INSTRUMENTS BOX PERFORATED	257	KRARNER-NEVINS BONE CHISEL	166
INSTRUMENTS BOX WITH HOOKS	257	L	
INSTRUMENTS BOX WITH LID	257	LA GRANGE SCISSORS TC	148
INSTRUMENTS MANAGEMENT SYSTEM	261	LA GRANGE SCISSORS	144
INSTRUMENTS TRAY PERFORATED	256, 264	LADMORE FILLING INSTRUMENTS	83
INSTRUMENTS TRAY PERFORATED BASE	264	LANGENBECK RETRACTOR	142
INSTRUMENTS TRAY SOLID BASE	264	LARGE FLUCH-CUT DISTAL END CUTTING PLIERS T.C	188
INSTRUMENTS TRAYS	256	LARGE SAW BLADES PLASTER SHEARS	178
INSTRUMENTS TRAYS WITH COVER	257	LAXUTOR ROOT ELEVATOR	47, 60
INSTRUMENTS TRAYS WITH LID	256	LE CRON CARVERS INSTRUMENTS	126
INSTRUMENTS TRAYS WITHOUT COVER	257	LE CRON WAX AND MODELLING CARVERS	125
INTERPROXIMAL FILLING INSTRUMENTS	89	LECLUSE BAYONET ROOTS ELEVATOR	57
IRIS SCISSORS TC	148	LEMPERT DELICATE BONE ROUNGER	175
IRIS ANGULAR, SAW EDGE SCISSORS.....	143	LESSMANN WAX KNIVES	127
IRIS SCISSORS	143	LIGATURE CUTTERS T.C	187
IVORY MATRIX RETAINERS	163	LIGATURE INSTRUMENTS	181
IVORY LIGHT WEIGHT RUBBER DAM CLAMPS FORCEPS	157	LIGATURE PLIERS	200
IVORY MATRIX RETAINERS	163	LIGATURE PLIERS T.C GOLD WITH TUNGSTEN CARBIDE INSERTS	200
IVORY RUBBER DAM CLAMPS FORCEPS	157	LINDO LEVIAN ROOT ELEVATORS	49
		LINGUAL / PALATAL ARCH FORMING PLIES	194
		LISTER BANDAGE SCISSORS	147

DESCRIPTION	PAGE #
LISTON BONE ROUNGER	176
LOCKLIN SCISSORS.....	145
LONDON COLLEGE TWEEZERS	65
LONDON HOSPITAL COLEMAN ROOTS ELEVATOR	52
LONG IMPLANT DRILLS SET OF 4 PCS	231
LOOP FORMING PLIER	195
LORNA TISSUE CLAMPS	152
LUCAS CURETTES	226
LUCAS SERRATED CURETTES	226
LUCAS SURGICAL CURETTE	121
LUER BONE ROUNGER	174
LUKS PERIODONTAL PROBES	77
LUXATOR ROOT ELEVATOR	42, 43
LUXIER ROOTS ELEVATOR	51
M	
MAGNIFYING MOUTH MIRRORS	63
MALLETS - PLASTER SHEARS - SAWS & BLADES	178
MARGINTRIMMERS FILLING INSTRUMENTS	91
MARKLEY FILLING INSTRUMENTS	79
MARQUETTE FILLING INSTRUMENTS	79
MARTIN BONE CURETTER ROUNG SHAPE	120
MATHIEU LIGATURE PLIERS	200
MATHIEU NEEDLE HOLDER	156
MATHIEU NEEDLE HOLDER TC.....	154
MATHIEU-KOCHER NEEDLE HOLDER	156
MATHIEU-KOCHER NEEDLE HOLDER TC.....	154
MATRIX RETAINERS	163
MAYO SCISSORS TC	148
MAYO SCISSORS.....	146
MAYO TRAY PERFORATED	256
MAYO-HEGAR NEEDLE HOLDERS	155
MAYO-HEGAR NEEDLE HOLDERS TC.....	153
McCALL PERIODONTAL INSTRUMENTS	110, 113
MEAD PERIODONTAL INSTRUMENTS	167
MEASURING LOOP	203
MEASURING LOOP ANGLED	203
MEASURING LOOP STRAIGHT	203
MEASURING LOOP, CASTROVIEJO ANGLED	203
MEASURING PROBE	202
MEAT PERIODONTAL INSTRUMENTS	169
MEDAN ROOTS ELEVATOR	53
MEISSNER EXTRACTING FORCEPS	38
MEMBRANE TWEEZERS KUEHNE	228
MERCURY FILLING INSTRUMENTS	89
MERIAM TWEEZERS	65
MERRIT EXPLORERS	72
MERSHON BAND PUSHER	183
MERSHON CROWN REMOVER	161
MESH TRAY	262
MESIAL & DISTAL ROOT ELEVATORS	50
MESIAL FILLING INSTRUMENTS	91
METAL TIP PLASTER SHEARS	178
METHIEU PLIER WITH RING	200
METHOT JAR WITHOUT LID	258
METZENBAUM SCISSORS TC	149

DESCRIPTION	PAGE #
METZENBAUM SCISSORS	143
MICOR ADSON TISSUE FORCEPS	227
MICRO FREER RASPATOR	224
MICRO FRIEDMAN 90° BONE ROUNGER	175
MICRO FRIEDMAN BONE ROUNGER	175
MICRO IRIS SCISSORS.....	143
MICRO LUER BONE ROUNGER	174
MICRO RASPATOR / CHISEL	224
MICRO-FREER RASPATOR	223
MILLER 1X CROSS CUT BONE FILES	166
MILLER 2X CROSS CUT BONE FILES	166
MILLER ARTICULATING PAPER FORCEPS	67
MILLER BONE FILES	166
MILLER CURETTES	226
MILLER ROOT ELEVATORS	48
MILLER ROOT PLANNING CHISELS & BONE FILES	166
MINI LIGATURE CUTTERS T.C	187, 188
MINI PIN & LIGATURE CUTTER TC. GOLD.	197
MINI RETRACTOR	141
MINI-LANGENBECK RETRACTOR	141
MINNESOTA CHEEK RETRACTOR	140
MISCELLANEOUS PRODUCTS	162
MIXING SPATULA WITH SHOVEL	218
MODELLING INSTRUMENTS	99
MODIED MCCALL PERIODONTAL INSTRUMENTS	110
MODIED MCCALL PERIODONTAL INSTRUMENTS HOLLOW HANDLE	113
MOLARS ROOTS ELEVATOR	52
MOLT PERIODONTAL INSTRUMENTS	169
MOLT RASPATOR	224
MOUTH GAG MOLT (ADULTS)	138
MOUTH GAG MOLT (CHILDREN)	138
MOUTH MIRRORS	63
MOUTH PROPS	162
MOVEABLE HEIGHT GAUGE	179
MULTIFUNCTIONAL METER	202
MULTI-PURPOSE PLIERS, BIRD BEAK, DE LA ROSA AND CUTTER	194
N	
NANCE LOOP FORMING PLIERS	186, 194
NANCE PLIER TC. GOLD.	198
NANCE PLIERS	186
NAPKIN HOLDER WITH METAL CHAIN	162
NAPKIN HOLDER WITH PLASTIC CHAIN	162
NARROW MATRIX RETAINERS	163
NEEDLE HOLDERS	153
NEEDLE STERILLIZATION TUB	259
NEUMANN SCISSORS.....	144
NEVIUS EXTRACTING FORCEPS	31
NOYES SCISSORS	146
NYSTRÖM LEFT MATRIX RETAINERS	163
NYSTRÖM RIGHT MATRIX RETAINERS	163
O	
OCHSENBEIN PERIODONTAL CHISELS	118



DESCRIPTION	PAGE #
OCHSENBIN PERIODONTAL INSTRUMENTS	167
OHL 10 PERIOSTEEL ELEVATORS	168
OLSEN-HEGAR NEEDLE HOLDER WITH SCISSORS	156
OLSEN-HEGAR NEEDLE HOLDER WITH SCISSORS TC	154
ORTHO BAND PUSHER SCALER	182
ORTHO INSTRUMENT	181
ORTHO LIGATURE DIRECTOR SINGLE ENDED	182
ORTHO LIGHT BAND PUSHER SCALER	183
ORTHO LIGHT DOUBLE ENDED LIGATURE DIRECTOR	182
ORTHO LIGHT DOUBLE ENDED LIGATURE DIRECTOR SCALER	183
ORTHO LIGHT LIGATURE SCALER	182
ORTHO LIGHT LIGATURE DIRECTOR	182
ORTHO LIGHT SCALER	181
ORTHODONTIC INSTRUMENTS	179, 181, 182
ORTHODONTICS PLIERS STANDS	201
ORTHOLITE LIGATURE DIRECTOR SCALER	182
OSTEOMETER CLAMP	203
OSTEOMETER MEASURING FORCEPS	179
OSTEOTOME	229, 230
OSTEOTOMY DEPTH GAUGE DOUBLE ENDED	202
OVAL SPOON EXCAVATORS	94
P	
P.K. THOMAS WAXING INSTRUMENTS	122
PALMER RUBBER DAM CLAMPS FORCEPS	157
PAPILLA RASPATOR	223
PARMLY EXTRACTING FORCEPS	30
PARTSCH CHISEL	167
PARTSCH GOUGES	167
PARTSON PERIODONTAL INSTRUMENTS	167
PDL ELEVATORS SET OF 7 PCS	61
PDL ELEVATORS SET OF 8 PCS	62
PEESO WIRE BENDING PLIERS	190
PEET SPLINTER FORCEPS	67
PERIO PROBE	71
PERIO PROBE WHO	71
PERIO PROBE WILLIAMS	71
PERIODONTAL FILES HOLLOW HANDLE	102
PERIODONTAL INSTRUMENTS	98, 99
PERIODONTAL INSTRUMENTS SET	100
PERIODONTAL INSTRUMENTS SOLID HANDLE	109
PERIODONTAL INSTRUMENTS SOLID	112
PERIODONTAL KNIVES	116, 117
PERIODONTAL PROBES	76, 77, 78
PERIODONTAL SET OF 10 PIECES	73
PERIODONTAL SURGERY	216
PERIOSTEALS ELEVATOR	223, 224, 225
PERIOSTEEL ELEVATORS	168
PERIOTOME ROOTS ELEVATOR	58
PERRY TWEEZERS	65
PHYSICK EXTRACTING FORCEPS	28
PIN & LIGATURE CUTTERS TC. GOLD.	197
PIN HOLDING PLIER	198
PIN-TWEEZERS	228

DESCRIPTION	PAGE #
PLAIN MOUTH MIRRORS	63
PLASTER KNIVES	128
PLASTER SHEAR SPECIAL INOX	129
PLASTER SHEARS WITH RUBBER GRIP	178
PLASTIC FILLING INSTRUMENTS	84, 85
PLIER STAND STAINLESS STEEL	201
PLIER STAND PLASTIC	201
PLIERS FOR ORTHODONTICS & PROSTHETICS	184
PLIERS TO PLACE MODULES	200
PLUGGERS	221
POINTED CURETTE PERIODONTAL	110, 113
POINTED PROBES DOUBLE ENDED HANDLE	72
POSIGRIP ARTICULATING PAPER FORCEPS	67
POSITIVE POSITIONER	179
POSTERIOR	78
POSTERIOR JACQUETTE PERIODONTAL INSTRUMENTS	109
POSTERIOR JACQUETTE PERIODONTAL INSTRUMENTS HOLLOW HANDLE	112
POTT ROOTS ELEVATOR	57
PRICHARD 3 PERIOSTEEL ELEVATORS	168
PRONG 3 CLASP ADJUSTABLE PLIER TC GOLD	198
RALK ROOT FRAGMENTS	18

R	
RASP, MOLT	225
RASPATOR, BENQUE	225
RASPATOR, NORDBERG	225
RASPATOR, PRICHARD	218
RASPATOR, RASPATORY	168, 223
RASPATOR, WAUTIER	225
RASPATOR, WILLIGER	168
RASPATORY MICRO MOLT	225
RASPATORY MOLT	225
REMINGTON HOE PERIODONTAL CHISELS	119
RETRACTOR WITH ERGO GRIP ERGONOMIC HANDLE	140
RETRACTORS - MOUTH GAGS	138
RHODES PERIODONTAL CHISELS	119
RHODIUM MOUTH MIRRORS	64
ROACH WAX AND MODELLING CARVERS	125
ROCHESTER-KOCHER 1X2 HAEMOSTATIC FORCEPS	150
ROCHESTER-PEAN HAEMOSTATIC FORCEPS	150
ROGGE TISSUE CLAMPS	152
ROMEROWSKI FILLING INSTRUMENTS	83
ROOT CANAL PLUGGER	75
ROOT PLANNING CHISELES & BONE FILES	166
ROOTS SPLINTER FORCEPS	18
ROSER-KONIG CHEEK RETRACTORS	139
ROUND BOWLS	258
ROUND BOWLS WITH COVER	260
ROUND BOWLS WITH OUT COVER	260
ROUND ENDODONTIC BOXES COMPLETE WITH LID	259
ROUND STERILIZER DRUM	260
ROUND STERILIZER DRUMS "FILTER"	260
ROUND TORQUE WRENCH	233

DESCRIPTION	PAGE #
RUBBER DAM CLAMPS	160
RUBBER DAM CLAMPS FORCEPS	157
RUBBER DAM CLAMPS KITS	159
RUBBER DAM FRAME	157
RUBBER DAM KITS	158
RUBBER DUM TEMPLATE	159
RUSKIN BONE ROUNGER	176
RUSSIAN LONG TISSUE FORCEPS	228
RUSSIAN TISSUE FORCEPS	228

S

SACHS WAX KNIVES	129
SCALAR SINGLE ENDED.....	114
SCALER CURETTE	110
SCALER CURETTE HOLLOW HANDLE	113
SCALERS TRAY	256
SCALPEL BLADE & SCALPEL KNIVES	136
SCALPEL HANDLE 6 WAY ADJUSTABLE	135
SCALPEL HANDLES	135
SCHLEMMER ROOTS ELEVATOR	52
SCHLUGER PERIODONTAL FILES	101, 102
SCHMECKEBIER ROOT ELEVATORS	46
SCHURE BAND SEATER	181
SCHWARZ PLIERS	190
SELDIN ROOTS ELEVATOR	53
SELDIN 23 PERIOSTEEL ELEVATORS	168
SELDIN RETRACTOR	142
SELDIN ROOT ELEVATOR	43, 44, 45, 50
SELF LOCKING GROOVED	227
SEMKEN TAYLOR TWEEZERS	65
SEPARATING FORCEPS	28
SEPARATING PLIERS FOR SEPARATORS	199
SHORT IMPLANT DRILLS SET OF 3 PCS	231
SICKLE SCALERS	108
SICKLE SCALERS HOLLOW HANDLE	111
SICKLE SCALERS INSTRUMENTS SOLID HANDLE	108
SINGLE ENDED CHEEK RETRACTORS	139
SINUS LIFT INSTRUMENTS HOLLOW HANDLE	209 - 215
SINUS WINDOW BONE TAMPERS	221
SIQVELAND RETAINERS	163
SMAHA ELASTOMERIC LIGATURE PLACING FORCEPS	199
SMALL FLUCH-CUT DISTAL AND CUTTING PLIERS T.C	188
SMALL SAW BLADES PLASTER SHEARS	178
SOFT WIRE AND LIGATURE CUTTER, 15° ANGLED TC	192
SOFT WIRE AND LIGATURE CUTTER, 45° ANGLED TC	192
SOFT WIRE AND LIGATURE CUTTER, MINI TC ...	192
SOFT WIRE AND LIGATURE CUTTER, STANDARD TC	192
SOLDERING PLIERS - TWEEZERS & SPLINTER FORCEPS	67
SOLDERING PLIERS	67
SOLT PERIODONTAL CHISELS	119

DESCRIPTION	PAGE #
SPATULAS	93
SPENCER SCISSORS.....	145
SPIRIT LAMP	259
SPOON AND PUSHER	220
SPOON AND PUSHER (TRINOVO)	222
SPOON AND PUSHER WITH SAFETY STOP	222
SPOON EXCAVATORS	94
SPREADERS	76
SPUTUM CUP	258
STANDARD LIGATURE CUTTER TC. GOLD.	197
STAR TORQUE WRENCH	233
STERIL SCALPEL BLADES	136
STERILIZING & TISSUE CLAMPS	152
STERILIZING BOXES & INSTRUMENTS TRAYS ..	257
STERILIZING MESH TRAY	262
STIEGLITZ ROOT FRAGMENTS	18
STIEGLITZ SPLINTER FORCEPS	67
STOCKES RUBBER DAM CLAMPS FORCEPS ...	157
STOP PLIERS V-BEBD TC	194
STRAIGHT DIRECT BOND BRACKET REMOVER T.C	198
STRIP SAW	179
SUCTION CANNULA KIT WITH 3 NEEDLES	237
SUCTION NEEDLE	237
SUCTION PIPE	237
SUCTION TUBES	236
SUGARMAN FILE SET	101
SUGARMAN FILE SET HOLLOW HANDLE	102
SUGARMAN PERIODONTAL FILES HOLLOW HANDLE.....	102
SURGICAL BALL HOOK CRIMPING PLIERS, ANGLED	194
SURGICAL BALL HOOK CRIMPING PLIERS, STRAIGHT TC	194
SURGICAL CHISELS	216
SURGICAL-FLAT RETRACTOR	142
SUTURE PLIERS SUTURE FORCEPS	227
SYNDESMOTOMES ROOTS ELEVATOR	58

T

TAMPER BONE MATERIAL	220
TANNER FILLING INSTRUMENTS	79
TARTER REMOVER INSTRUMENTS.....	115
TG PERIODONTAL CHISELS	119
THERMO FORMING PLIERS	196
THICK GROOVED PLIER	191
TISSUE FORCEPS TWEEZERS	66
TISSUE GRAFT FORCEPS SERRATED TEETH ...	227
TISSUE MEMBRANE FORCEPS	227
TISSUE PUNCH FORCEPS TO REMOVE TISSUE	228
TISSUE PUNCH SET OF 5 PCS	231
TISSUE PUNCH STRAIGHT & CURVED	232
TISSUE PUNCH WITH PIN SET OF 4 PCS	231
TITANIUM GRAFT PACKER/ PLACEMENT SITE DEPTH GAUGE	219
TITANIUM METAL LOCKING PLIER	227
TOFFLEMIRE-JUNIOR MATRIX RETAINERS	163
TOFFLEMIRE-SENIOR MATRIX RETAINERS	163



DESCRIPTION	PAGE #
TOFFLEMIRE-UNIVERSAL MATRIX RETAINERS	163
TOMAS EXTRACTING FORCEPS (AMERICAN PATTERN)	31
TOMAS EXTRACTING FORCEPS (FOR CHILDREN)	20
TOMATI BONE ROUNGER	176
TORQUE WRENCH & RATCHET	233
TORQUING PLIERS	194
TOWNER PERIODONTAL INSTRUMENTS	108, 111
TOWNER-JACQUETTE PERIODONTAL INSTRUMENTS	108, 111
TRELAT PERIOSTEEL ELEVATORS	168
TREPINE DRILL	231
TREPINE DRILL SET OF 8 PCS	231
TUNNELIERUNGS INSTRUMENT	220
TWEED / ANGEL RECTANGULAR ARCH FORMING AND TORQUING PLIERS TC	194
TWEED / ANGLE RECTANGULAR ARCH FORMING & TORQUING PLIERS	189
TWEED LOOP FORMING PLIERS	186
TWEED LOOP PLIER	187
TWEEZERS	65
TWIEL-ON ELASTIC MODULE INSTRUMENT	181
U	
UNIQUE RETRACTOR	141
UNIVERSAL CROWN SCISSORS	147
UNIVERSAL DOLPHIN STYLE WIRE BENDING & CUTTING PLIERS	190
UNIVERSAL PLIER	189
UNIVERSAL PLIERS FOR SOFT AND HARD WIRE	191
UNIVERSAL SCISSORS TC	149
UNIVERSITY OF MICHIGAN EXPLORERS	71, 72
UNIVERSITY OF NORTH CAROLINA EXPLORERS	71
UTILITY PLIER WEINGART TC. GOLD.	198
V	
V BENDING PLIERS	189
VEHE WAX AND MODELLING CARVERS	125
W	
W. BARRY ROOTS ELEVATOR	57
WAHL BONE FILES	166
WAKEFIELD 1W PERIODONTAL INSTRUMENTS	167
WAKEFIELD 2W PERIODONTAL INSTRUMENTS	167
WALDSACHS WIRE BENDING AND CUTTING PLIERS	190
WANGEN HOLDER WITH OR WITHOUT LIP PROTECTION	138
WARD FILLING INSTRUMENTS	88
WATER SYRINGE	164
WAX AND MODELLING CARVERS	125
WAX KNIVES	127 TO 129
WAX SPATULAS WOODEN HANDLE	130
WEDELSTAEDT FILLING INSTRUMENTS	90

DESCRIPTION	PAGE #
WEINGART PLIER MEDIUM	189
WEINGART UTILITY PLIERS TC	193
WEINGART-MINI UTILITY PLIERS TC	193
WEITLANDER CHEEK RETRACTORS	139
WEITLANER CHEEK RETRACTORS	139
WESTCOTT FILLING INSTRUMENTS	83
WHITE PLASTIC FILLING INSTRUMENTS	85
WHITE ROOT ELEVATOR	54
WIDE MATRIX RETAINERS	163
WILAND FILLING INSTRUMENTS	89
WILLIAM PROBE SET OF 8 PCS DOUBLE ENDED	74
WILLIAMS EXPLORERS	71, 72
WILLIGER BONE FILES	166
WINTER EXTRACTING FORCEPS	28
WINTER ROOTS ELEVATOR	57
WIRE BENDING AND LOOP FORMING PLIERS ANGLED (BIRD BEAK) TC	193
WISDOM EXTRACTING FORCEPS	16
WISDOM ROOTS ELEVATOR	51
WOODSON PLASTIC FILLING INSTRUMENTS	85
X	
X RAY FILM HANGER	162
Y	
YOUNG TONGUE FORCEPS	151
YOUNG WIRE BENDING & LOOP FORMING PLIERS	187
YSTROM FILLING INSTRUMENTS	90
Z	
ZAHLE WAX AND MODELLING CARVERS	125



THANKS FOR VIEW OUR CATALOGUE

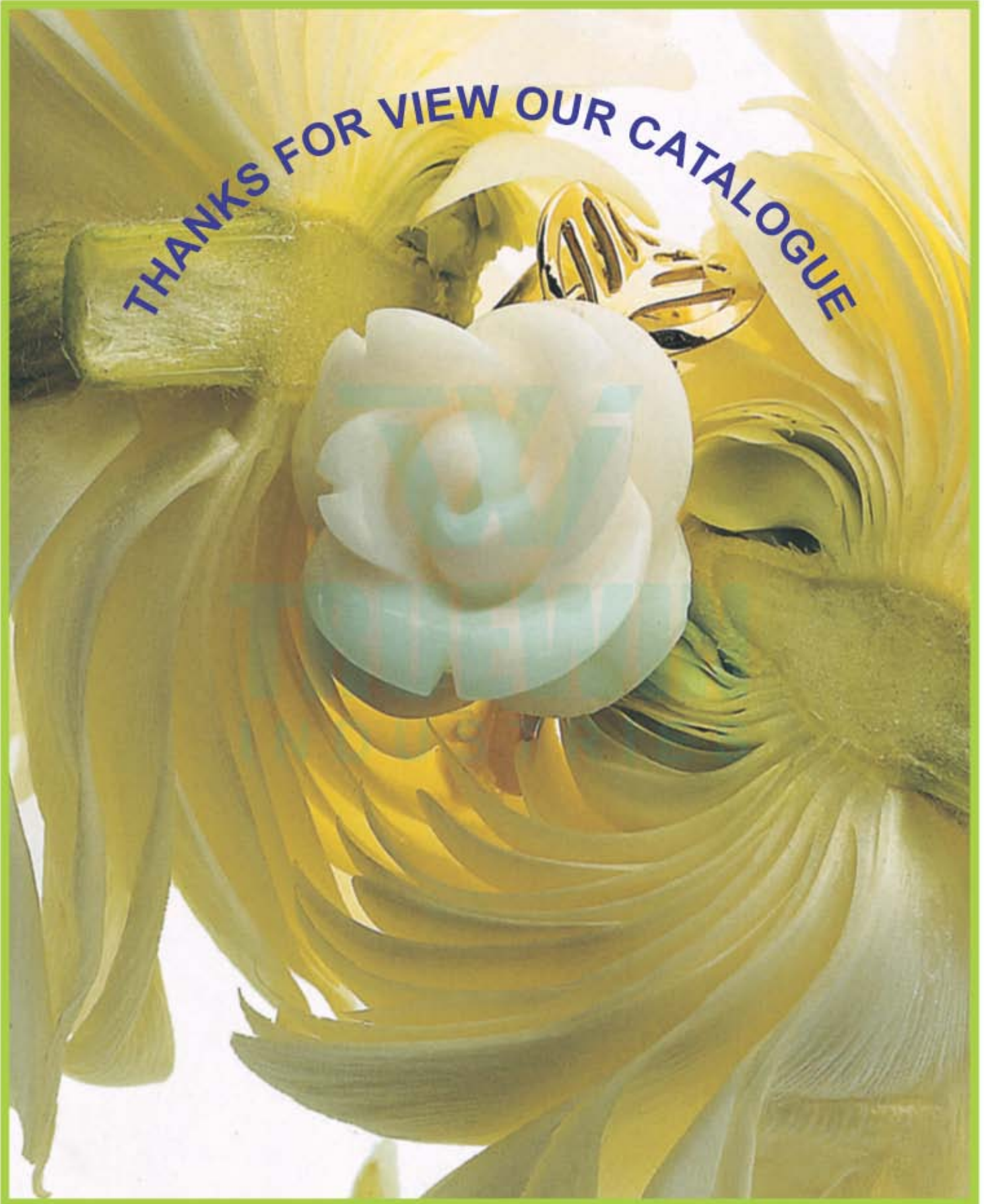

TRUEWIN INDUSTRIES

Manufacturers & Exporters of Dental Instruments.

Roras Road New Miana Pura, Sialkot Pakistan

Ph: +92-52-3251044 Fax: +92-52-3251045

E-mail: info@truewin.com.pk truewin786@gmail.com

www.truewin.com.pk

